



integral solutions

**ALUMINIUM
PVC**

archi tecture

CONTEMPORARY
ENCLOSURES



Aluminium and PVC
for **architecture**

INDEX

15

HINGED

16	Cor 80 Industrial Passivhaus
17	Cor 80 Industrial
20	Cor 70 Industrial
22	Cor 80 Hidden Sash
24	Cor 70 Hidden Sash
26	Cor 70 OC
30	Alu-Steel
32	Cor 60
34	Cor 60 Hidden Sash
35	Cor 3500
36	Cor 3000
38	Cor 2000
39	Cor 2300
40	Cor 70 C16 ST
42	Cor 70 Evolution
46	Cor 70 Hidden Sash C16 ST
48	Cor 3500 C16 ST
50	Cor Urban C16
52	Cor Galicia Premium C16
54	Casement



57

DOORS

58	Millennium Plus 80 Door
59	Millennium Plus 70 Door
62	Millennium Plus Pivot Door
64	Panelled Door
66	Millennium 2000 Door
68	Millennium Sliding Automatic Door
70	Bi-Fold
71	Bi-Fold Plus

75

SLIDING

76	Cor Vision Plus
80	Cor Vision Evolution
82	Cor Vision
84	4600 Plus Lift & Slide
86	4700 In-line Slider / Lift & Slide
88	4900 HI Sliding
90	4200 Sliding
92	5000 Double Sliding
93	5000 Sliding / Integral Sliding
94	Mediterranean Balcony
96	2000 Perimetral Sliding
97	6200 Sliding
98	6500 Sliding
99	6500 Plus Sliding

103

PVC

104	A 84 Passivhaus HI
105	A 84 Passivhaus 1.0 Thermally broken A 84 Passivhaus 1.0
106	A 84 Hinged
109	A 84 Hidden Sash Passivhaus 1.0 A 84 Hidden Sash
110	A 78 Hinged A 78 Passivhaus 1.0 Hinged
112	A 70 Hinged
116	Alcover
118	C 70 Sliding
120	E 170 Lift & Slide
124	Cortizo Isolation Roller Shutter Box
126	Cassonetto Renovation Shutter Box

127

FAÇADE SYSTEMS

129	Engineering for Building Envelopes
130	Modular Façade
132	Light Façades
133	Stick 62 Façades
137	TP 52 Façade
138	SG 52 Façade
141	TPH 52 Façade
142	TPV 52 Façade
144	ST 52 Façade
145	SST 52 Façade
149	Equity Façade
150	Skylight - Veranda
152	Sliding Roof

155

SMOKE AND FIRE PROTECTION

157	Millennium FR Door
158	SHEV

161

CLADDINGS

163	Cladding Pro
------------	--------------

165

INTERIOR DIVISIONS

167	PW 80 Office Partition Wall
168	Design 35 Screen & Internal Door

171

SOLAR PROTECTION

172	Solar Protection Louvres
173	Decorative Lattices & Louvres
176	Jalousie
178	Tamiz
179	Mallorquina

183

BALUSTRADE

184	View Crystal Fit Plus Balustrade
186	View Crystal Balustrade View Crystal Plus Balustrade
188	Classic Balustrade
190	Juliet Balcony

193

ACCESSORIES



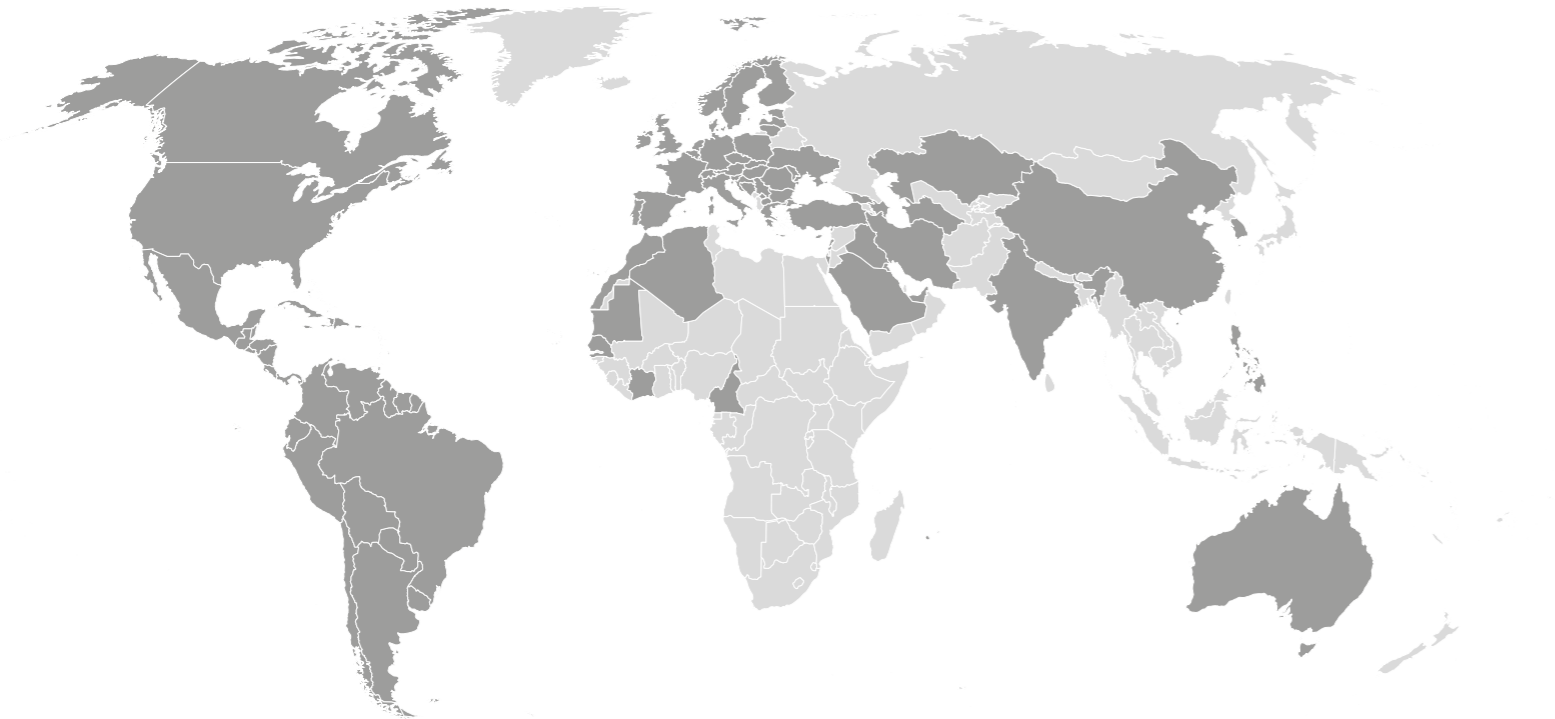

CORTIZO

GLOBAL PRODUCTION CAPACITY



CORTIZO, an international leader in the design and manufacture of aluminium and PVC. Our production capacity consists of 150,000 t of aluminium and 45,000 t of PVC. This enables us to meet the requirements of our customers across more than 80 countries in which we are currently present.

U value chart



ALUMINIUM

SYSTEM	Uf W/m²K	Uw W/m²K
Cor 80 Industrial Passivhaus	0.94	From 0.66
Cor 80 Industrial	1.1	From 0.71
Cor 80 Hidden Sash	1.2	From 0.71
Cor 70 Industrial	1.3	From 0.76
Cor 70 Hidden Sash	1.4	From 0.84
Alu-Steel	1.5	From 0.83
Cor 70 Evolution	1.5	From 0.8
Bi-Fold Plus	1.7	From 0.78
Millennium Plus 80 Door	1.7	From 0.8
Cor 70 C16 ST	1.7	From 0.9
Cor 70 OC	1.7	From 0.85
4600 Plus Lift & Slide	1.8	From 0.65
Cor 70 Hidden Sash C16 ST	1.8	From 0.93
Cor Galicia Premium C16	2.1	From 1.1
Millennium Plus Pivot Door	2.2	From 0.77
Cor 3500 Hinged	2.3	From 1.0
Cor Urban C16	2.3	From 1.2
Millennium FR Door	2.4	From 1.4
Millennium Plus 70 Door	2.5	From 0.9
Cor 3500 C 16 ST	2.7	From 1.2
Casement	2.7	From 0.9

Consult typology, dimensions and glazing.
Consult transmittance of different joints.

SYSTEM	Uf W/m²K	Uw W/m²K
4900 HI Sliding	2.7	From 1.2
Cor 60 Hinged	2.8	From 1.0
Bi-Fold	2.8	From 0.97
Cor Vision Evolution	3.2	From 0.88
4700 In-line Slider / Lift & Slide	3.4	From 1.0
Cor 3000 Hinged	3.4	From 1.3
Cor 60 Hidden Sash Hinged	3.6	From 1.5
Cor Vision Plus Sliding	3.8	From 0.9
Cor Vision Sliding	3.9	From 1.3
4200 Sliding	4.0	From 1.5
5000 Double Sliding	4.0	From 1.3
Cor 2000 Hinged	5.7	From 1.8
Cor 2300 Hinged	5.7	From 2.0
6200 Sliding	5.7	From 3.2
Millennium 2000 Door	5.7	From 2.3
Mediterranean Balcony	5.7	From 2.1
2000 Perimetral Sliding	5.7	From 2.9
5000 Sliding	5.7	From 2.3
6500 Sliding	5.7	From 2.2
6500 Plus Sliding	5.7	From 2.0

// Completed projects



Halletts Point
New York, USA

PVC

SYSTEM	Uf W/m²K	Uw W/m²K
A 84 Passivhaus HI Hinged	0.76	From 0.66
A 78 Passivhaus 1.0 Hinged	1.00	From 0.74
A 84 Passivhaus 1.0 Reduced Reinforcement Hinged	1.00	From 0.74
A 84 Passivhaus 1.0 Hinged	1.01	From 0.74
A 84 Hidden Sash Passivhaus 1.0	1.05	From 0.71
A 84 Hidden Sash	1.11	From 0.74
A 84 Hinged	1.16	From 0.79
A 78 Hinged	1.20	From 0.80
A 70 Hinged	1.3	From 0.9
C 70 Sliding	1.8	From 1.3
E 170 Lift & Slide	1.6	From 0.9

Consult typology, dimensions and glazing.
Consult transmittance of different joints.

CORTIZO ISOLATION	U _{SB} SHUTTER BOX
Roller Shutter box 200 mm	0.66 (W/m²K)
Roller Shutter box 160 mm	0.97 (W/m²K)

// Ongoing projects



_ Pilatus Tower
Switzerland



_ World Trade Center Santo Domingo
Dominican Republic



_ 121 Broadway Cambridge
USA

investigation, advancement and quality



CORTIZO IS QUALITY

The quality of all CORTIZO products is based on the strict tests carried out in official, national and international laboratories, as well as by our technical staff in our own test benches.

R+D

Design, innovation and quality are the protagonists in the more than 80 window, door, façade, composite panel, balustrade and solar protection systems designed by our R&D department. CORTIZO enclosures adapt to the climate and construction particularities of thousands of projects around the world. Single-family and collective housing, hospitals and health centres, hotels, administrative buildings, infrastructures, sports centres, commercial and industrial spaces, social and cultural centres...

The adequate selection of raw materials and the control of all parameters that influence the extrusion process, backed by the ISO 9001 international certification, guarantee the quality of the extruded material. Additionally, the meticulous work in the execution of the surface treatments has allowed us to obtain the most demanding European quality certificates, such as QUALICOAT, QUALIDECO and QUALICOAT SEA SIDE for the laquering process, and the EWWA-EURAS for the anodizing process.





CORTIZO LAB

The Cortizo LAB software allows for the immediate production of calculations, test results and classifications of all enclosure systems designed by CORTIZO and tested in its Technological Centre, for any dimension, typology and glazing (windows, doors, double joinery, façades, roofs and louvres).

Thermal performance

Acoustic performances

AEV Tests:

- Window and door systems: EN 12207 / EN 12208 / EN 12210

- Façades: EN 12152 / EN 12154 / EN 13116

Microventilation

Mechanical Calculations

Calculation and production of wind and snow load reports

CORTIZO BIM

Virtual management of enclosure designs

BIM training

Personalized assistance

BIM customized solution designs

Founded on the 3D reproduction of each of the structural elements that make up a building, this technology allows for a more quick and comprehensive parametric design of the projects, offering digital replicas of our enclosure systems. The BIM library incorporates intelligent objects that implicitly carry all the technical, thermal, acoustic and mechanical information, virtually reproducing their behaviour in reality.



TSAC NETWORK

Personalised technical assistance to architecture professionals in their own geographic working area is a differentiating fact of the CORTIZO spirit. For this purpose, we have a network of 22 Proximity Architecture and Engineering Departments strategically located in different areas in Europe and America.

Finite Element Method for Structural Computation

Documents of compliance with regulations and standards

Official tests and certifications from the CORTIZO Technology Centre

Design and assessment of customised profiles for each project

Resolution of details and meeting on site

BIM comprehensive assistance



Santander Bank Headquarters
Spain

// Completed projects

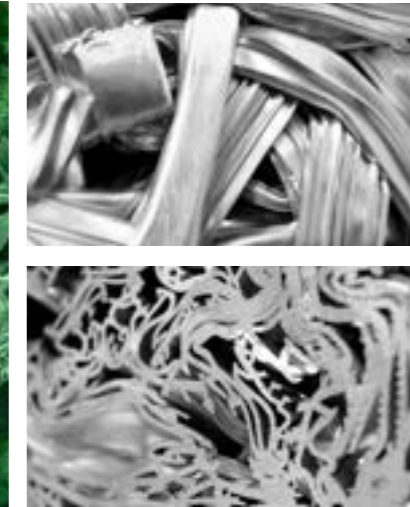

CORTIZO ECOEFFICIENT

Aluminium life cycle "cradle to cradle".
Via its two foundries, CORTIZO RECYCLING transforms aluminium waste into raw material for the extrusion of profiles, thus closing the cycle of a 100% reusable material.
More than 2400 pick-up points of aluminium scrap in Europe.
Low energy consumption in recycling (only 5% compared to primary consumption).
Officially certified purifying stations



Green building consultation
greenbuilding@cortizo.com

contemporary
enclosures



hinged window and door systems

COR 80

Industrial Passivhaus

Certified for the warm-temperate category, this system offers exceptional thermal insulation thanks to its special foams on the frame and sash. With a transmittance value U_w from just $0.66 \text{ W/m}^2\text{K}$, it is an ideal solution for buildings with low energy consumption.

European Groove
Thermally broken

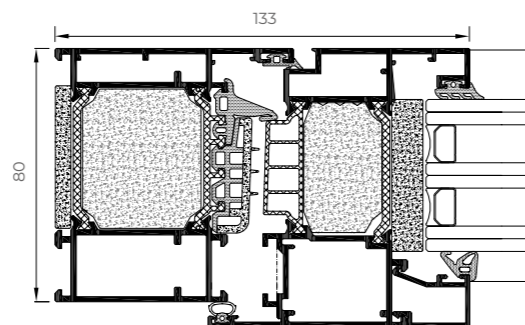

FEATURES		
Transmittance		$U_w \geq 0.66 \text{ (W/m}^2\text{K)}$
Acoustic insulation		Rw up to 46 dB
Air permeability		Class 4
Watertightness		Class E1950
Wind resistance		Class C5

Reference test 1.23 x 1.48 m / 2 sashes

POSSIBILITIES



OPENING POSSIBILITIES



Inward Opening
Side hung
Tilt & turn
Parallel Sliding
Bottom hung



Sightlines

Frame 80 mm, Sash 88 mm

Profile Thickness

1.6 mm

Polyamide Strip Length

45 mm

Glazing

Max. 65 mm, Min. 16 mm

Maximum Sash Dimensions

Width (L) 1500 mm, Height (H) 2600 mm

Maximum Sash Weight

160 kg

Consult maximum weight and dimensions according to typologies.



Aesthetic possibilities:

Sash: Straight / Glazing bead: Straight or curved

COR 80

Industrial

With a 80 mm frame depth, the COR 80 Industrial series responds to the most severe climatic requirements thanks to its thermal break with 45 mm tubular polyamide strips and the incorporation of reticulated polyolefin both around the glass and between the frame and sash.

FEATURES

Transmittance		$U_w \geq 0.71 \text{ (W/m}^2\text{K)}$
Acoustic insulation		Rw up to 46 dB
Air permeability		Class 4
Watertightness		Class E1950
Wind resistance		Class C5
Burglar resistance		Grade RC2 (WK2)

Reference test 1.23 x 1.48 m / 2 sashes

POSSIBILITIES



OPENING POSSIBILITIES

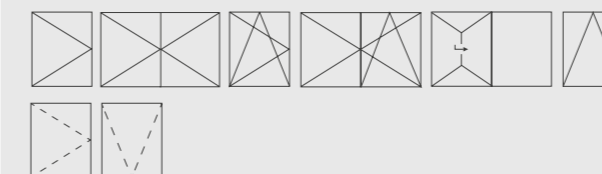

Inward Opening

Side hung
Tilt & turn
Parallel Sliding
Bottom hung

Outward Opening

Side hung
Top hung

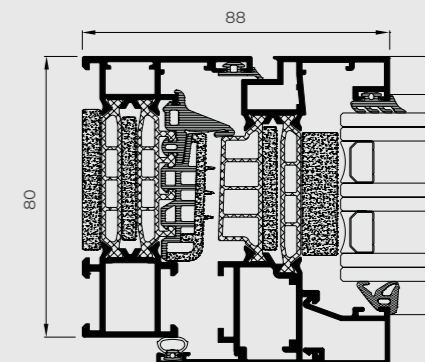

Sightlines

Frame 80 mm, Sash 88 mm

Profile Thickness

1.5 mm

Polyamide Strip Length

45 mm

Glazing

Max. 73 mm, Min. 16 mm

Maximum Sash Dimensions

Width (L) 1500 mm, Height (H) 2600 mm

Maximum Sash Weight

160 kg

Consult maximum weight and dimensions according to typologies.



Aesthetic possibilities:

Sash: Straight / Bead: Straight or curved



COR 80 INDUSTRIAL



COR 80 INDUSTRIAL
ROLLER BLIND INTEGRATED INTO GLAZING BEAD

ROLLER BLIND INTEGRATED INTO GLAZING BEAD

The new glass roller blind solution for the COR 80 and 70 Industrial is completely integrated into the window thanks to the design of a top glazing bead that fully conceals the rolling system and driving motor. In addition, the special lateral glazing beads act as guides, ensuring that the roller blind remains flush with the window, even during the opening and closing manoeuvres of the sash.

Available for **COR 80 and 70 Industrial systems**

Aesthetic uniformity

Total integration into the window, allowing for complete darkening of spaces with opaque roller blinds

Smooth sliding without wobbling during opening and closing manoeuvres

Compatible with **automated home systems**.

COR 70

Industrial

This 70 mm frame depth hinged system offers great thermal and acoustic performance combined with very simple fabrication, which is why it has become one of the most requested series for aluminium windows, doors and balconies.

European Groove
Thermally broken



Cor 70 Industrial - Concealed drainage solution



Cor 70 Industrial - Half-Hidden Sash

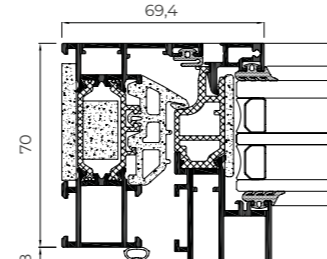
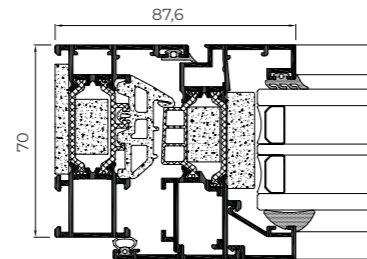

FEATURES

Transmittance		Uw ≥ 0.76 (W/m²K)
Acoustic insulation		Rw up to 44 dB
Air permeability		Class 4
Watertightness		Class E1800
Wind resistance		Class C5
Burglar resistance		Grade RC2 (WK2)
Standard AAMA Test		Class AW-PG60 *
Security test		Passed

Reference test 1.23 x 1.48 m / 2 sashes

Security test: Reference test 1.100 x 2.400 m / 1 sash

Burglar test 1.47 x 2.52 m / 1 sash with EVO SECURITY hardware

CSTB Laboratory DTA Certification

*Standard AAMA Test: Class AW-PG60 1502 x 2502 - FW / Reference test fixed 150 x 250 m

OPENING POSSIBILITIES

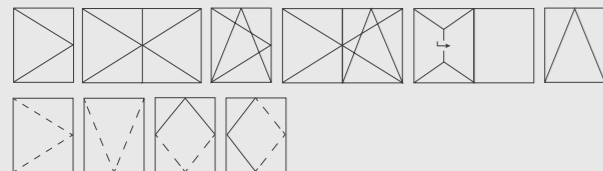

Inward Opening

Side hung
Tilt & turn
Parallel Sliding
Tilt only

Outward Opening

Side hung
Top hung
Pivoting on horizontal or vertical axis

POSSIBILITIES



SECURITY HARDWARE



CONCEALED HINGES



INTEGRATED ROLLER BLIND

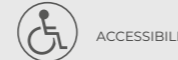

ACCESSIBILITY



CONCEALED DRAINAGE

COR 70 INDUSTRIAL



Sightlines

Frame 70 mm, Sash 78 mm

Polyamide Strip Length

From 32 / 35 mm
35 mm (Half-Hidden Sash)

Profile Thickness

Window 1.5 mm
Door 1.7 mm
Window 1.9 mm (Half-Hidden Sash)

Glazing

Max. 63 mm, Min. 6 mm
Max. 40 mm, Min. 26 mm (Half-Hidden Sash)

Maximum Sash Dimensions

Width (L) 1500 mm, Height (H) 2600 mm

Half-Hidden Sash:

Width (L) 1300 mm, Height (H) 2400 mm
Standard solution

Width (L) 1200 mm, Height (H) 3000 mm
HD Hinges (side hung)

Maximum Sash Weight

160 kg

Aesthetic possibilities:

Sash: Straight / Glazing bead: Straight or curved

Consult maximum weight and dimensions according to typologies

COR 80

Hidden Sash

Elegant design with straight aesthetic in which the sash is concealed behind the frame, thus maximizing the glazed surface and the entry of light. In addition, it offers a great thermal and acoustic performance prompted by the 45 mm thermal break and a glazing capacity of up to 51 mm that allows the installation of triple glazing.

European Groove
Thermally broken



FEATURES

Transmittance		$U_w \geq 0.71$ (W/m ² K)
Acoustic insulation		Rw up to 46 dB
Air permeability		Class 4
Watertightness		Class E1650
Wind resistance		Class C5

Reference test 1.23 x 1.48 m / 2 sashes



POSSIBILITIES



OPENING POSSIBILITIES

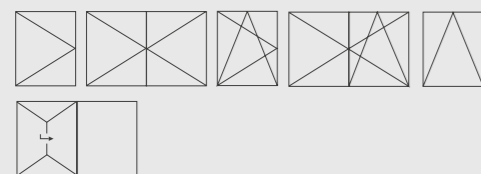

Inward Opening

Side hung
Tilt & turn
Bottom hung
Parallel Sliding

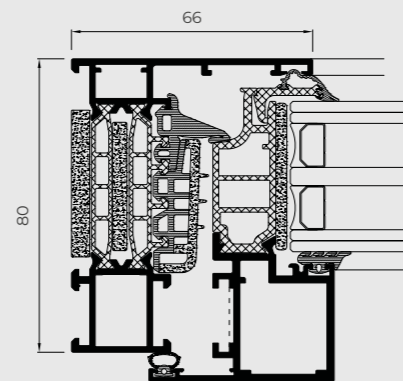

Sightlines

Frame 80 mm, Sash 80 mm

Polyamide Strip Length

45 mm

Profile Thickness

Window 1.9 mm

Glazing

Max. 51 mm, Min. 36 mm

Maximum Sash Dimensions

Standard Solution:

Width (L) 1300 mm, Height (H) 2400 mm

HD Hinges (Side Hung):

Width (L) 1200 mm, Height (H) 3500 mm

Maximum Sash Weight

160 kg

Consult maximum weight and dimensions according to typologies

First invisible handle on the market



Solution for hidden sash systems **COR 80 HS, COR 70 HS and COR 70 OC**

Dimensions: **27.5 mm (L) x 234 mm (H)**

Ergonomics, robustness and easy handling in opening and closing operations.

Totally clean aesthetics that simulate a fixed element, when in fact, it is a side hung or tilt & turn opening.



ARCH
INVISIBLE
BY CORTIZO



Exclusive handle integrated within the sash, **imperceptible from a frontal view.**

Possibility of concealed hinges that consolidates the aesthetic purity of the system.

COR 70

Hidden Sash



It could be a painting, but is a window. This is how we can describe the COR 70 Hidden Sash which, like the 80 mm version, has a sightline of only 66 mm and allows the incorporation of the ARCH INVISIBLE handle, concealed hinges and the drainage solution. Any element that breaks the visual harmony of the ensemble is discarded.

FEATURES

Transmittance		$U_w \geq 0.84$ (W/m ² K)
Acoustic insulation		Rw up to 46 dB
Air permeability		Class 4
Watertightness		Class E1800
Wind resistance		Class C5
Security test		Passed

Reference test: 1.23 x 1.48 m / 1 sash
 Security test: Reference test 1.100 x 2.400 m / 1 sash
 CSTB Laboratory DTA Certification

POSSIBILITIES

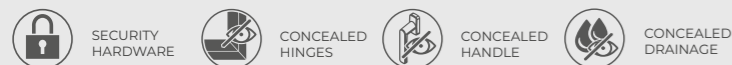

OPENING POSSIBILITIES



Inward Opening

Side hung
 Tilt & turn
 Bottom hung
 Parallel Sliding

European Groove
 Thermally broken

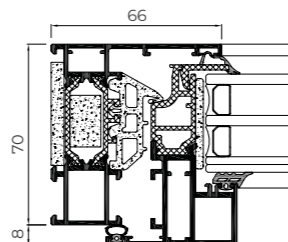

COR 70 Hidden Sash

Sightlines
 Frame 70 mm, Sash 70 mm
Polyamide Strip Length
 35 mm
Profile Thickness
 Window 1,9 mm

Glazing
 Max. 40 mm, Min. 26 mm

Maximum Sash Dimensions
Standard solution:
 Width (L) 1300 mm, Height (H) 2400 mm

HD Hardware (Side Hung):
 Width (L) 1200 mm, Height (H) 3500 mm

Maximum Sash Weight
 160 kg

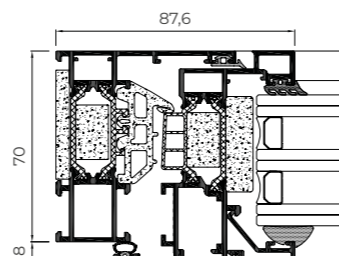

COR 70 Hidden Sash - Half-Hidden Solution

Sightlines
 Frame 70 mm, Sash 78 mm
Polyamide Strip Length
 32-35 mm
Profile Thickness
 Window 1,5 mm

Glazing
 Max. 55 mm, Min. 26 mm

Maximum Sash Dimensions
 Width (L) 1000 mm
 Height (H) 1700 mm

Maximum Sash Weight
 160 kg

Consult maximum weight and dimensions according to typologies



COR 70 HIDDEN SASH

CONCEALED DRAINAGE SOLUTION

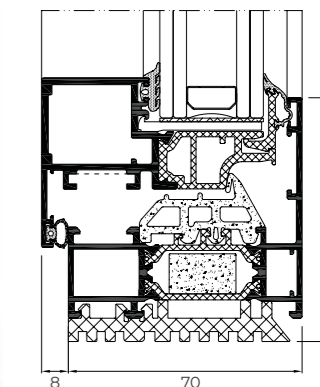

Minimizes the aesthetic impact of the window components.

Compatible with all the 70 mm frame depth systems.

It features a gasket at the bottom of the frame to evacuate the water, replacing the front drainage caps.

Facilitates window fabrication, allowing to place the base of the frame on the site itself.

COR 70 OC

European Groove
Thermally broken



Hidden sash system oriented to the French market with monoblock frame that makes installation easier. Using this new frame allows faster fabrication and installation, avoiding overlaps, cills and any other complementary profiles, speeding up assembly and fitting. The fabricator can choose either straight or 45 degree cut.

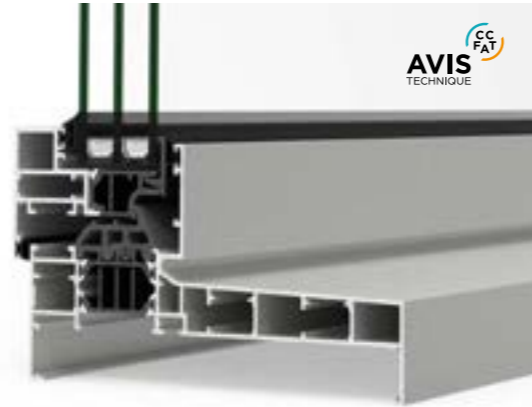

* COR 70 OC - Mitred frame

COR 70 OC

Sightlines

Frame 70 - 232 mm, Sash 70 mm

Polyamide Strip Length

35 mm

Profile Thickness

Window 1.9 mm

Glazing

Max. 40 mm, Min. 26 mm

Maximum Sash Dimensions

Standard solution:

Width (L) 1300 mm, Height (H) 2400 mm

HD Hardware (Side Hung):

Width (L) 1200 mm, Height (H) 3500 mm

Maximum Sash Weight

160 kg

Consult maximum weight and dimensions according to typologies

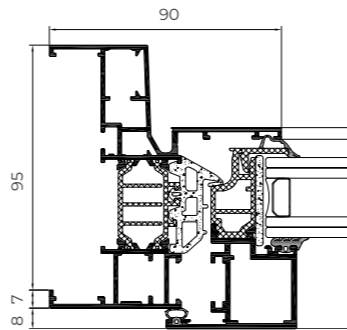

* COR 70 OC - Mitred frame

The half hidden sash version of the COR 70 OC allows to expand the aesthetic possibilities of this series with monoblock frame available at straight or 45 degree cut.

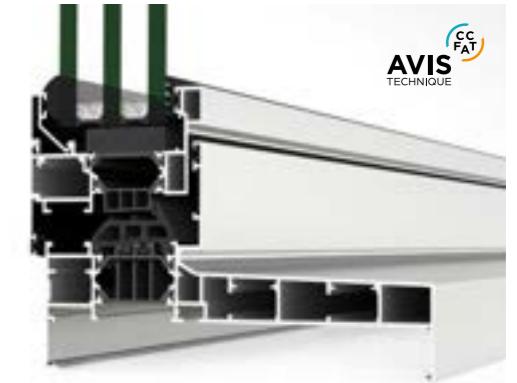

* COR 70 OC Half Hidden sash - Mitred frame

COR 70 OC - Half-Hidden Sash

Sightlines

Frame 70 - 232 mm, Sash 78 mm

Polyamide Strip Length

32-35

Profile Thickness

Window 1.5 mm

Glazing

Max. 55 mm, Min. 15 mm

Maximum Sash Dimensions

Width (L) 1000 mm, Height (H) 1700 mm

Maximum Sash Weight

160 kg

Consult maximum weight and dimensions according to typologies

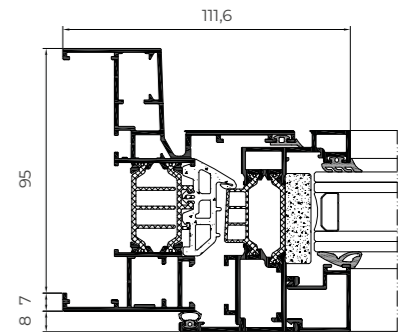

* COR 70 OC Half Hidden sash - Mitred frame

FEATURES

Transmittance		Uw ≥ 0.85 (W/m²K)
Acoustic insulation		Rw up to 46 dB
Air permeability		Class 4
Watertightness		Class E1650
Wind resistance		Class C5

Reference test 1.23 x 1.48 m / 1 sash
CSTB Laboratory DTA Certification

POSSIBILITIES

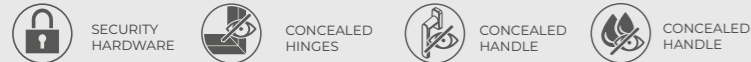

OPENING POSSIBILITIES

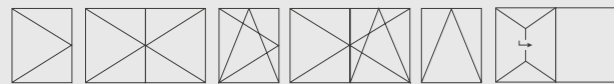

Inward Opening

Side hung
Tilt & turn
Bottom hung
Parallel Sliding

FEATURES

Transmittance		Uw ≥ 0.9 (W/m²K)
Acoustic insulation		Rw up to 44 dB
Air permeability		Class 4
Watertightness		Class E1800
Wind resistance		Class C5

Reference test 1.23 x 1.48 m / 2 sashes
CSTB Laboratory DTA Certification

POSSIBILITIES

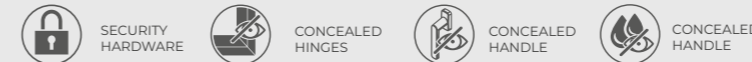

OPENING POSSIBILITIES

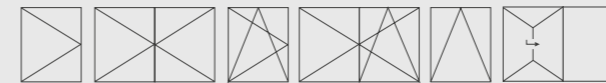

Inward Opening

Side hung
Tilt & turn
Bottom hung
Parallel Sliding

aesthetic possibilities



COR 70 OC
Straight cut frame



COR 70 OC
Perimetral frame



COR 70 OC - Half-Hidden sash
Straight cut frame



COR 70 OC - Half-Hidden sash
Perimetral frame



ALU-STEEL



Inspired by classic line designs, the new Alu-Steel system allows to combine aluminium outstanding performances values with a steel-alike appearance. With a sightline of only 72.5 mm, Alu-Steel is the perfect solution for new buildings and refurbishments, offering two different versions, classic or modern.



*Classic version



*Modern version

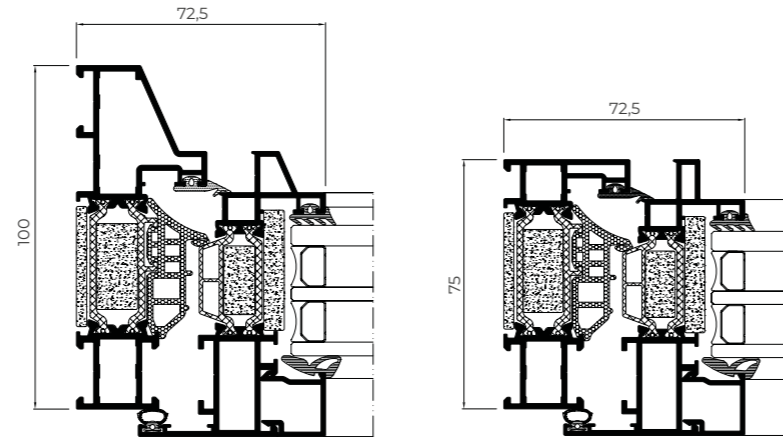

*Classic version

*Modern version

European Groove
Thermally broken



POSSIBILITIES



SECURITY HARDWARE



CONCEALED HINGES



CONCEALED HANDLE



ACCESSIBILITY

OPENING POSSIBILITIES



Inward Opening

Side hung
Tilt & turn
Bottom hung

Outward Opening

Side hung

FEATURES

Transmittance		$U_w \geq 0.83 (W/m^2K)$
Acoustic insulation		Rw up to 45 dB
Air permeability		Class 4
Watertightness		Class E1200
Wind resistance		Class C5

Reference test 1.23 x 1.48 m / 2 sashes

ALU-STEEL



Sightlines

Modern frame 75 mm
Classic frame 100 mm
Sash 83 mm

Polyamide Strip Length

32-39 mm

Profile Thickness

Window 1.5 mm

Glazing

Max. 54 mm, Min. 20 mm

Maximum Sash Dimensions

Width (L) 1500 mm, Height (H) 2600 mm

Maximum Sash Weight

160 kg

Consult maximum weight and dimensions according to typologies

COR 60

European Groove
Thermally broken



Hinged system with 60 mm of frame depth, featuring 24 mm polyamide strips, which provides a notable thermal and acoustic comfort, achieving a noise reduction of up to 48 dB.



Sightlines

Frame 60 mm, Sash 68 mm

Polyamide Strip Length

24 mm

Profile Thickness

Window 1.6 mm

Door 1.6 mm

Glazing

Max. 46 mm, Min. 5 mm

Maximum Sash Dimensions

Width (L) 1500 mm, Height (H) 2600 mm

Maximum Sash Weight

160 kg

Consult maximum weight and dimensions according to typologies.

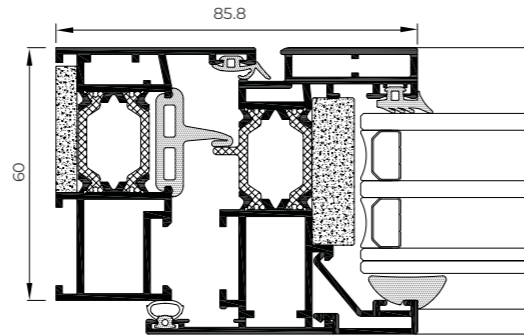

Aesthetic possibilities:

Sash: Straight or curved
Glazing Bead: Straight or curved

FEATURES

Transmittance		$U_w \geq 1.0$ (W/m ² K)
Acoustic insulation		Rw up to 48 dB
Air permeability		Class 4
Watertightness		Class E1350
Wind resistance		Class C5

Reference test 1.20 x 1.16 m / 2 sashes

POSSIBILITIES



SECURITY HARDWARE



CONCEALED HINGES



ACCESSIBILITY

OPENING POSSIBILITIES

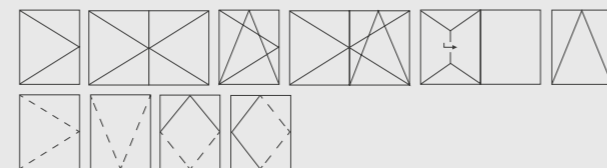

Inward Opening

Side hung
Til & turn
Parallel Sliding
Bottom hung

Outward Opening

Side hung
Top hung
Pivoting on horizontal or vertical axis.



COR 60

COR 60

Hidden Sash

Minimalism for avant-garde projects. It has an interlock profile of only 63 mm, COR 60 Hidden Sash is presented as a hinged system that allows for more glazed surface.

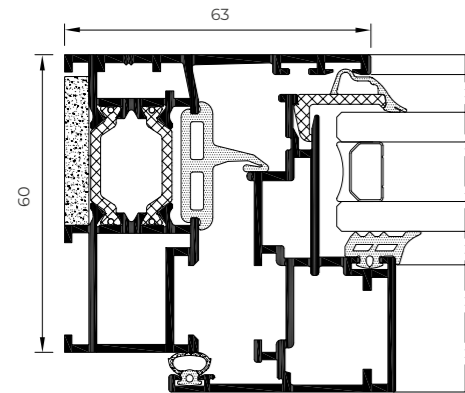

European Groove
Thermally broken



Sightlines

Frame 60 mm, Sash 60 mm

Polyamide Strip Length

24 mm

Profile Thickness

Window 1.6 mm

Balcony 1.6 mm

Glazing

Max. 34 mm, Min. 16 mm

Maximum Sash Dimensions

Width (L) 1300 mm, Height (H) 2400 mm

Maximum Sash Weight

160 kg

Consult maximum weight and dimensions according to typologies

FEATURES

Transmittance $U_w \geq 1.5 (W/m^2K)$

Acoustic insulation R_w up to 45 dB

Air permeability Class 4

Watertightness Class 9A

Wind resistance Class C5

Reference test 1.13 x 1.16 m / 1 sash

POSSIBILITIES



SECURITY HARDWARE



CONCEALED HINGES

OPENING POSSIBILITIES

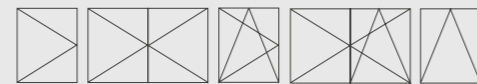

Inward Opening

Side hung
Tilt & turn
Bottom hung

COR 3500

Hinged system with a frame depth of 54 mm, a 24 mm thermal break zone, and a maximum glazing capacity of 41 mm. These features grant this system optimal thermal and acoustic performances: U_w from 1.0 W/m^2K , and up to 46 dB of noise reduction.



Sightlines

Frame 54 mm, Sash 63 mm

Polyamide Strip Length

24 mm

Profile Thickness

Window 1.5 mm

Door 1.7 mm

Glazing

Max. 41 mm, Min. 5 mm

Maximum Sash Dimensions

Width (L) 1500 mm, Height (H) 2400 mm

Maximum Sash Weight

120 kg

Consult maximum weight and dimensions according to typologies

Aesthetic possibilities:

Sash: Straight or curved
Glazing Bead: Straight or curved

FEATURES

Transmittance $U_w \geq 1.0 (W/m^2K)$

Acoustic insulation R_w up to 46 dB

Air permeability Class 4

Watertightness Class E1200

Wind resistance Class C5

Reference test 1.20 x 1.20m / 2 sashes

European Groove
Thermally broken

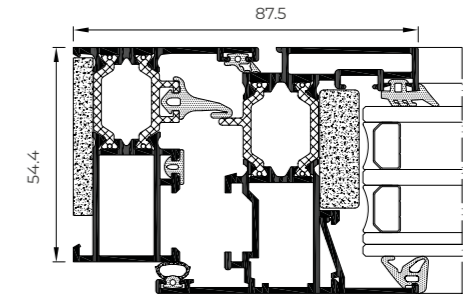

POSSIBILITIES



SECURITY HARDWARE



CONCEALED HINGES



ACCESSIBILITY

OPENING POSSIBILITIES

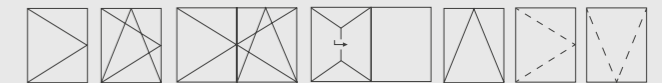

Inward Opening

Side hung
Tilt & turn
Parallel Sliding
Bottom hung

Outward Opening

Side hung
Top hung

COR 3000

Hinged system with a 45 mm frame depth and a thermal break of 14.6 mm. This is a versatile system, suitable for mild climates, and with a large variety of opening possibilities.

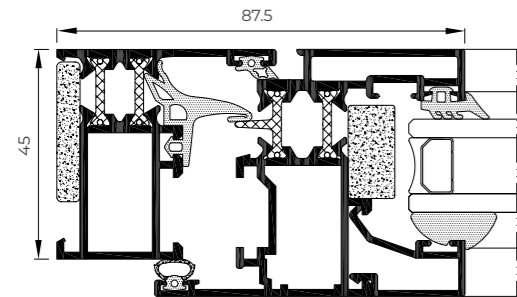

European Groove
Thermally broken



Sightlines
Frame 45 mm, Sash 53 mm
Polyamide Strip Length
14.6 mm
Profile Thickness
Window 1.5 mm
Door 1.7 mm
Glazing
Max. 31 mm, Min. 3 mm
Maximum Sash Dimensions
Width (L) 1500 mm, Height (H) 2400 mm
Maximum Sash Weight
120 kg
Consult maximum weight and dimensions according to typologies

Aesthetic possibilities:
Sash: Straight or curved
Glazing Bead: Straight or curved

OPENING POSSIBILITIES

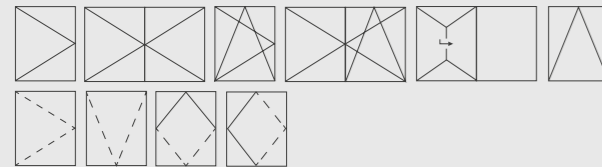

Inward Opening
Side hung
Tilt & turn
Parallel Sliding
Bottom hung

Outward Opening
Side hung
Top hung
Pivoting of either horizontal or vertical axis

POSSIBILITIES



SECURITY
HARDWARE



CONCEALED
HINGES

FEATURES

Transmittance		$U_w \geq 1.3$ (W/m ² K)
Acoustic insulation		Rw up to 46 dB
Air permeability		Class 4
Watertightness		Class 9A
Wind resistance		Class C5

Reference test 1.18 x 1.18m / 2 sashes



COR 3000

COR 2000

Euro-groove hinged system with a glazing capacity of 31 mm. Its profile thickness, of 1.5 mm in the window version and 1.7 mm in the door version, provides it with exceptional rigidity and durability.

FEATURES

Transmittance		$U_w \geq 1.8$ (W/m ² K)
Acoustic insulation		Rw up to 39 dB
Air permeability		Class 4
Watertightness		Class 9A
Wind resistance		Class C5

Reference test 1.20 x 1.18 m / 2 sashes

OPENING POSSIBILITIES

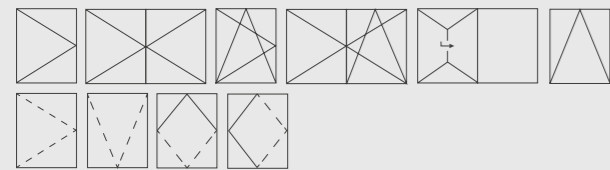

Inward opening

Side hung
Tilt & turn
Parallel Sliding
Bottom hung

Outward Opening

Side hung
Top hung
Pivoting of either horizontal or vertical axis

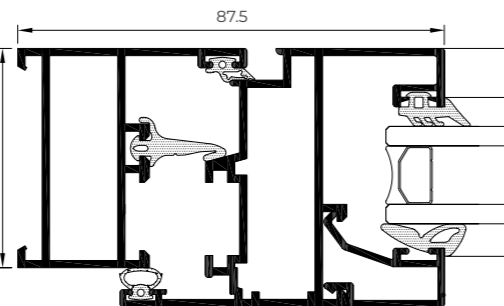

POSSIBILITIES



Sightlines

Frame 45 mm, Sash 53 mm

Profile Thickness

Window 1.5 mm

Door 1.7 mm

Glazing

Max. 31 mm, Min. 3 mm

Maximum Sash Dimensions

Width (L) 1500 mm, Height (H) 2400 mm

Maximum Sash Weight

120 kg

Consult maximum weight and dimensions according to typologies



Aesthetic possibilities:

Sash: Straight or curved
Glazing Bead: Straight or curved

European Groove



COR 2300

Hinged system with a frame depth of 40 mm and a reduced profile thickness.

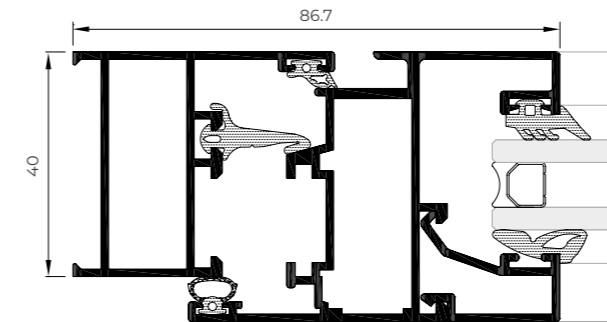

POSSIBILITIES



OPENING POSSIBILITIES

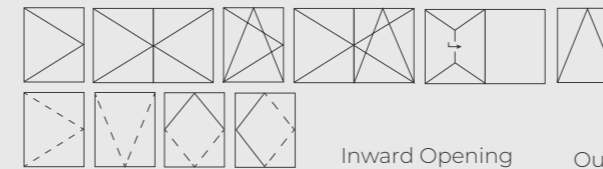

Inward Opening

Side hung
Tilt & turn
Parallel Sliding
Bottom hung

Outward Opening

Side hung
Top hung
Pivoting of either horizontal or vertical axis

FEATURES

Transmittance		$U_w \geq 2.0$ (W/m ² K)
Acoustic insulation		Rw up to 39 dB
Air permeability		Class 4
Watertightness		Class 9A
Wind resistance		Class C5

Reference test 1.105 x 1.210 m / 2 sashes

POSSIBILITIES



OPENING POSSIBILITIES

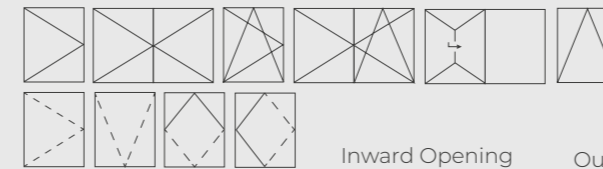

Inward Opening

Side hung
Tilt & turn
Parallel Sliding
Bottom hung

Outward Opening

Side hung
Top hung
Pivoting of either horizontal or vertical axis



Aesthetic possibilities:

Sash: Straight or curved
Glazing Bead: Straight or curved

Sightlines

Frame 40 mm, Sash 48 mm

Profile Thickness

Window 1.3 mm

Door 1.4 mm

Glazing

Max. 26 mm, Min. 4 mm

Maximum Sash Dimensions

Width (L) 1500 mm, Height (H) 2400 mm

Maximum Sash Weight

120 kg

Consult maximum weight and dimensions according to typologies

European Groove







COR 70

C16 ST

Hinged system with a 70 mm frame depth compatible with any standard 16 groove hardware. It features a 35 mm thermal break zone in the frame and 30 mm in the sash, providing it with great thermal and acoustic performance.

16 Groove
Thermally broken

FEATURES

Transmittance		$U_w \geq 0.9$ (W/m ² K)
Acoustic insulation		R _w up to 46 dB
Air permeability		Class 4
Watertightness		Class E1500
Wind resistance		Class C5

Reference test 1.23 x 1.48 m / 2 sashes
CSTB Laboratory DTA Certification

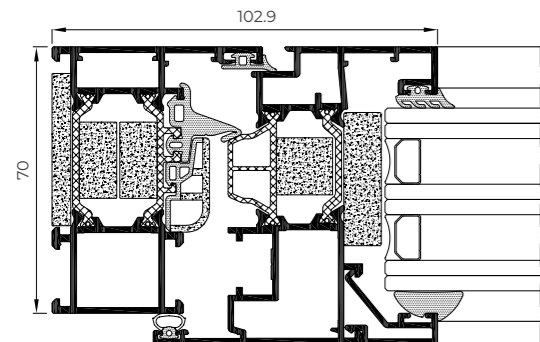

POSSIBILITIES



OPENING POSSIBILITIES

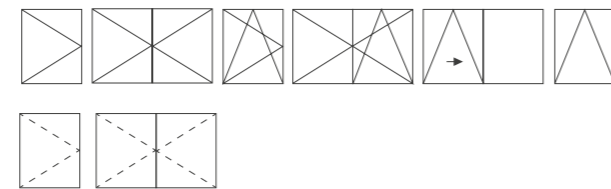

Inward Opening

Side hung
Tilt & turn
Tilt & parallel
Bottom hung

Outward Opening

Side hung (door)



Aesthetic possibilities:
Sash: Straight
Glazing Bead: Straight or curved

Sightlines

Frame 70 mm, Sash 78 mm

Polyamide Strip Length

Frame 35 mm

Sash 30 mm

Profile Thickness

Window 1.5 mm

Door 1.7 mm

Glazing

Max. 55 mm, Min. 15 mm

Maximum Sash Dimensions

Width (L) 1500 mm, Height (H) 2600 mm

Maximum Sash Weight

150 kg

Consult maximum weight and dimensions according to typologies







COR 70 C16 ST

COR 70

Evolution

Hinged system with groove 16 destined for the industrial production of windows, doors and balconies. In order to reduce the manufacturing period, this new series offers the possibility of using pre-assembled gaskets, assembling cleats and a central floating mullion with a two piece hidden sash, which allows the glazing of double-sash windows on site. COR 70 Evolution is presented in a version of hidden or half-hidden sash with monoblock frames, in straight cut or perimetral, aiming at facilitating the on-site installation.

FEATURES

Transmittance		$U_w \geq 0.8$ (W/m ² K)
Acoustic insulation		Rw up to 43 dB
Air permeability		Class 4
Watertightness		Class E1500
Wind resistance		Class C5

Reference test 1.23 x 1.48 m / 2 sashes

POSSIBILITIES



OPENING POSSIBILITIES



Inward Opening
Side hung
Tilt & turn
Bottom hung

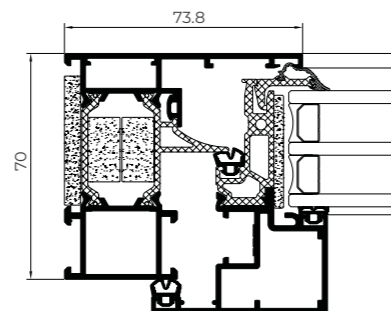
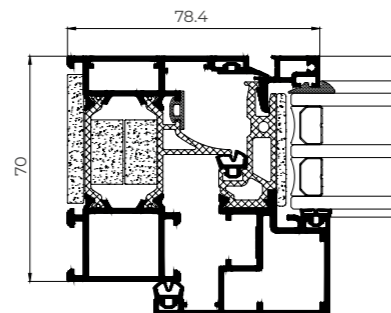

Hidden sash / Slim half-hidden sash

Sightlines

Frame 70 - 232 mm (hidden sash)

Frame 70 mm (slim half-hidden sash)

Sash 72.5 - 80.5 mm

Glazing

36 mm

Maximum Sash Dimensions

Width (L) 1300 mm, Height (H) 2400 mm

Maximum Sash Weight

150 kg

Consult maximum weight and dimensions according to typologies

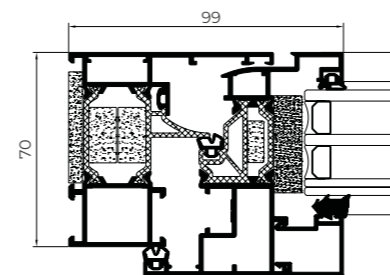
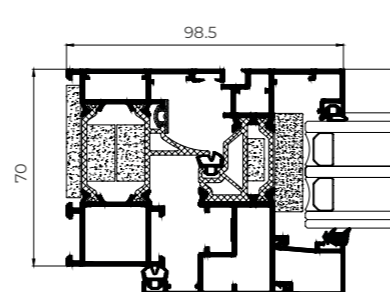

Half-hidden sash / Visible sash

Sightlines

Frame 70 - 232 mm (half-hidden sash)

Frame 70 mm (visible sash)

Sash 80.5 - 88.5 mm

Glazing

63 mm

Maximum Sash Dimensions

Window:

Width (L) 1000 mm, Height (H) 1700 mm

Balcony / Door:

Width (L) 1500 mm, Height (H) 2600 mm

Maximum Sash Weight

150 kg

16 Groove
Thermally broken

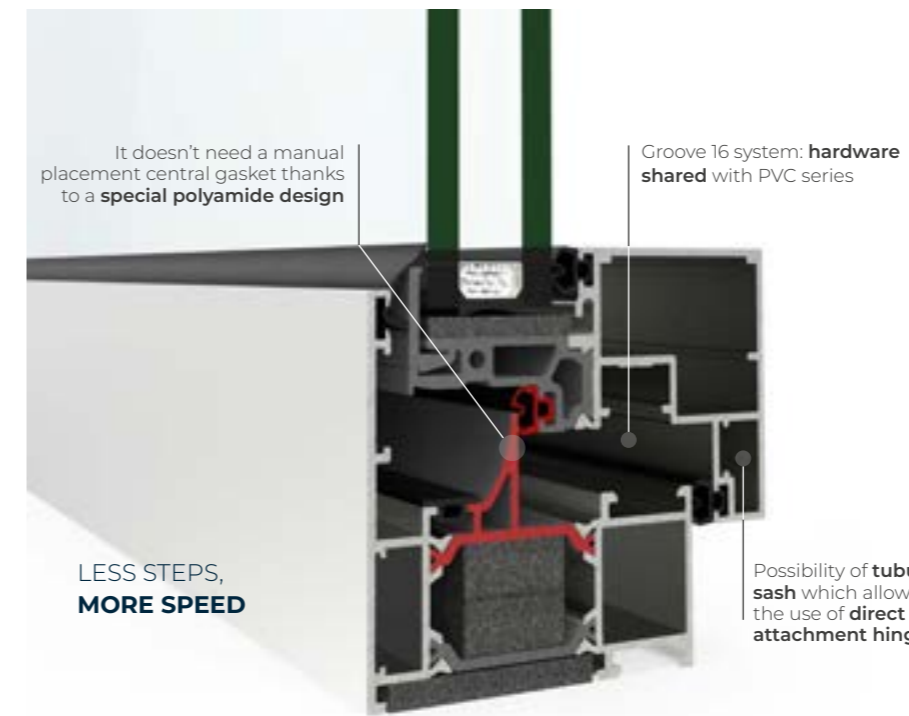

MANUAL GLAZING GASKETS AVAILABLE



Glazing gasket
6.5 mm



Glazing gasket
8.5 mm



Glazing gasket
2.5 mm



Glazing gasket
4.5 mm

POSSIBILITY OF PROVIDING PREASSEMBLED GASKETS

Gaskets available in black and grey

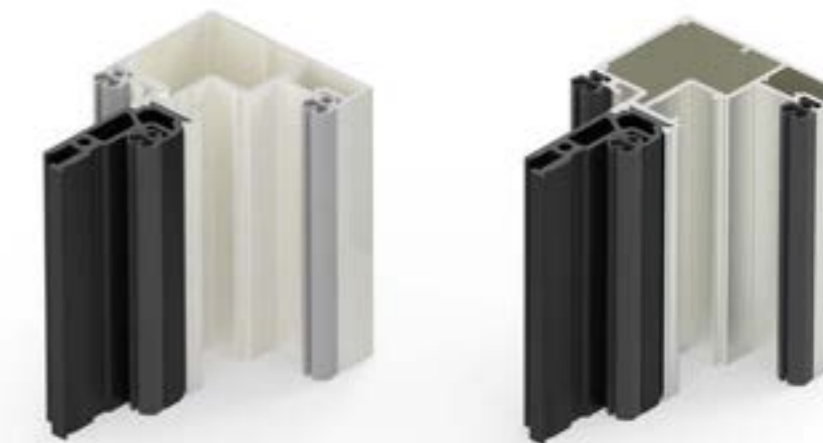

aesthetic possibilities



16 Groove
Thermally broken



Covers available
in black or white



COR 70
Evolution

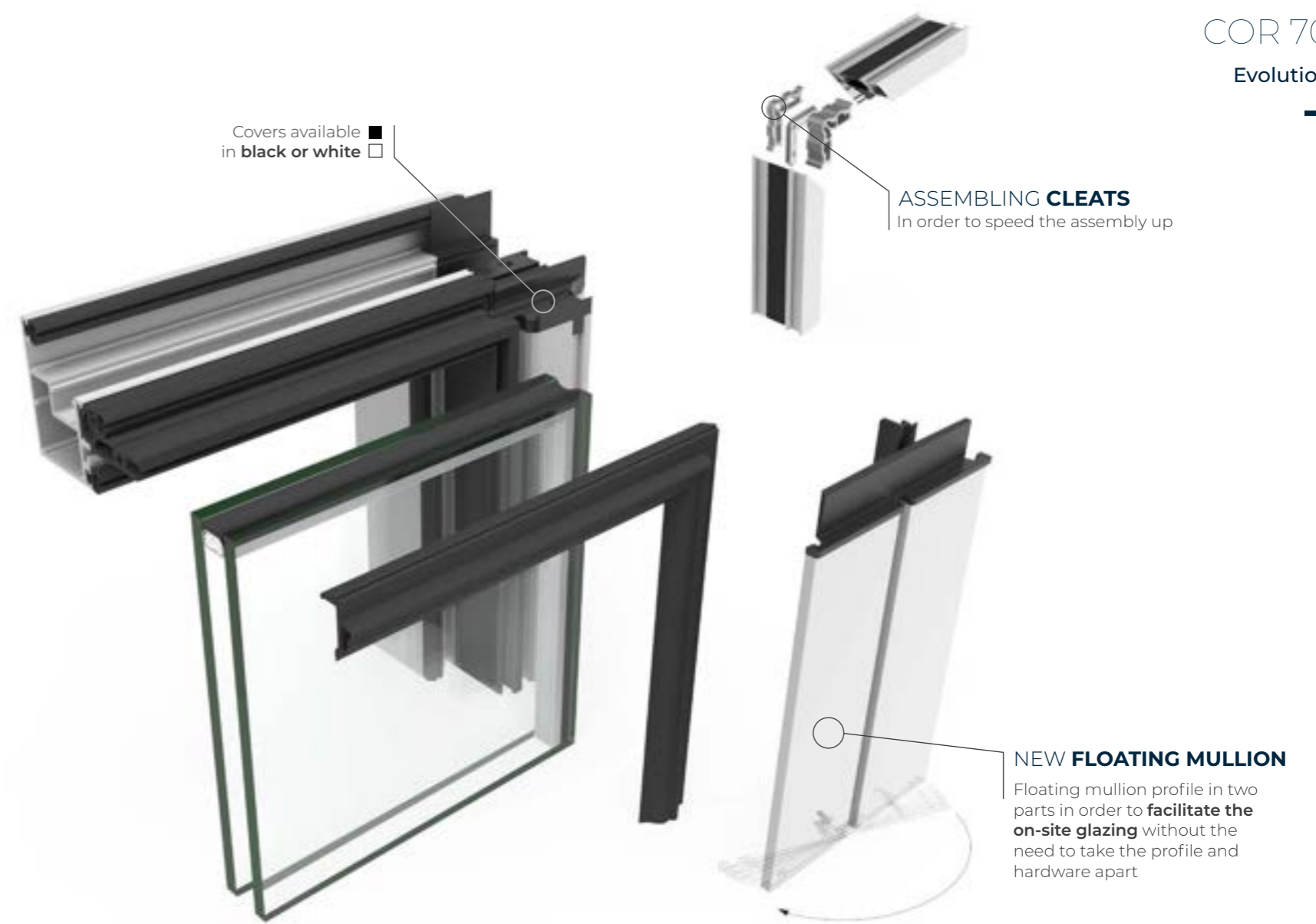

ASSEMBLING CLEATS
In order to speed the assembly up

NEW FLOATING MULLION
Floating mullion profile in two parts in order to **facilitate the on-site glazing** without the need to take the profile and hardware apart

COR 70

Hidden Sash C16 ST

16 Groove
Thermally broken



Hidden sash hinged system compatible with any standard 16 groove hardware. Its attractive design is based on the concealment of the sash behind the frame, reducing the aluminium interlock profile to up to 73.8 mm. Thus achieving a glazed surface that can reach 85% of the totality of the window's glazing, facilitating the entry of light into the rooms. Its avant-garde aesthetic is completed with the possibility of concealing the drainage and hinges.

OPENING POSSIBILITIES

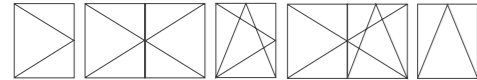

Inward Opening
Side hung
Tilt & turn
Bottom hung

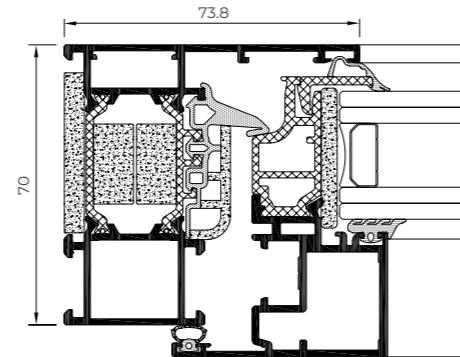

Sightlines

Frame 70 mm, Sash 70 mm

Polyamide Strip Length

35 mm

Profile Thickness

Window 1.6 mm

Glazing

Fixed light: Max. 40 mm, Min. 27 mm

Window: Max. 38 mm, Min. 24 mm

Maximum Sash Dimensions

Width (L) 1300 mm, Height (H) 2400 mm

Maximum Sash Weight

150 kg

Consult maximum weight and dimensions according to typologies

POSSIBILITIES



SECURITY HARDWARE



CONCEALED HINGES



CONCEALED DRAINAGE

FEATURES

Transmittance		$U_w \geq 0.93 (W/m^2K)$
Acoustic insulation		Rw up to 45 dB
Air permeability		Class 4
Watertightness		Class E1200
Wind resistance		Class C5

Reference test 1.23 x 1.48 m / 2 sashes
CSTB Laboratory DTA Certification



* Possibility of concealed drainage

COR 70 HIDDEN SASH C16 ST



COR 3500

C16 ST

Compatible with any standard 16 groove hardware in the market. This hinged system has a 54 mm frame depth and a thermal break zone of 24 mm. It is presented as a versatile solution for mild climates.

POSSIBILITIES



FEATURES

Transmittance		$U_w \geq 1.2$ (W/m ² K)
Acoustic insulation		Rw up to 46 dB
Air permeability		Class 4
Watertightness		Class 9A
Wind resistance		Class C4

Reference test 1.23 x 1.48 m / 2 sashes

OPENING POSSIBILITIES

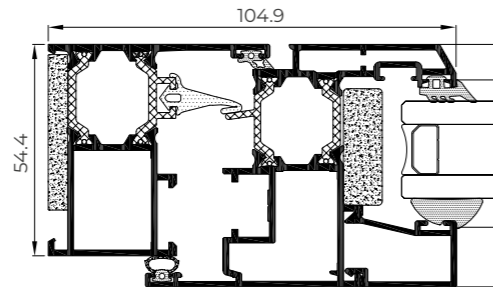
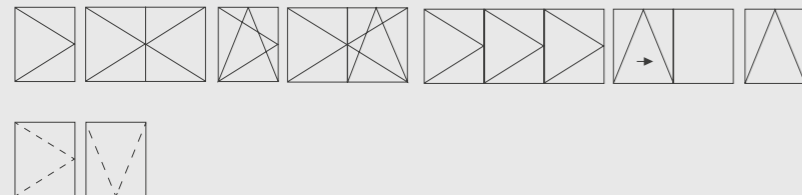

Aesthetic possibilities:

Sash: Curved or chamfered
Glazing Bead: Straight or curved



16 Groove
Thermally broken

COR 3500 C16 ST



Sightlines

Frame 54 mm, Sash 62 mm

Polyamide Strip Length

24 mm

Profile Thickness

Window 1.5 mm

Door 1.7 mm

Glazing

Max. 32 mm, Min. 27 mm

Maximum Sash Dimensions

Width (L) 1500 mm, Height (H) 2600 mm

Maximum Sash Weight

120 kg

Consult maximum weight and dimensions according to typologies

COR URBAN

C16

This system is especially suitable for buildings located in areas with high acoustic activity. This thermally broken window with double hidden sash of 122 mm, quadruple glazing and 4 gaskets, enables a noise reduction of up to 50 dB.

16 Groove
Thermally broken

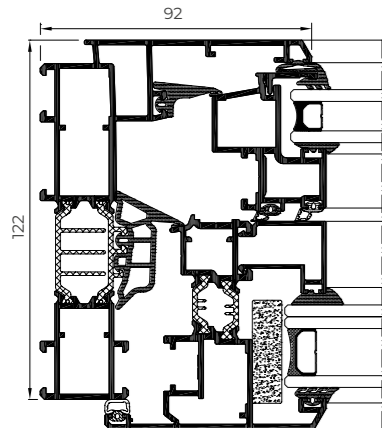

Sightlines

Frame 122 mm, Sash 121 mm

Polyamide Strip Length
Frame 35 mm, Sash 20 mm

Profile Thickness

Window 1.6 mm

Glazing

Internal sash: Max. 38 mm, Min. 13 mm

External sash: Max. 22 mm, Min. 11 mm

Maximum Sash Dimensions

Width (L) 1200 mm, Height (H) 2200 mm

Maximum Sash Weight

150 kg

Consult maximum weight and dimensions according to typologies



Aesthetic possibilities:

Sash: Chamfered / Glazing Bead: Chamfered

POSSIBILITIES



CONCEALED HINGES

OPENING POSSIBILITIES

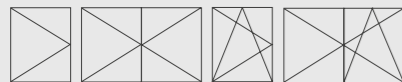

Inward opening

Side hung
Tilt & turn

FEATURES

Transmittance $U_w \geq 1.2 (W/m^2K)$

Acoustic insulation R_w up to 50 dB

Air permeability Class 4

Watertightness Class E1650

Wind resistance Class C5

Reference test 1.23 x 1.48 m / 1 sash



COR GALICIA

Premium C16

Thermally broken mixed system that combines an external aluminium profile and its excellent performance with the warmth and design that an internal timber profile provides. Any of the finishes amongst the extensive range of CORTIZO powder coating or anodizing finishes may be selected for the surface treatment of the external face. On the other hand, the internal face is available in American oak, sapelly, mellis pine and other timber options available on request, all of them treated with a transparent, satin, dissolvent free ecological varnish.

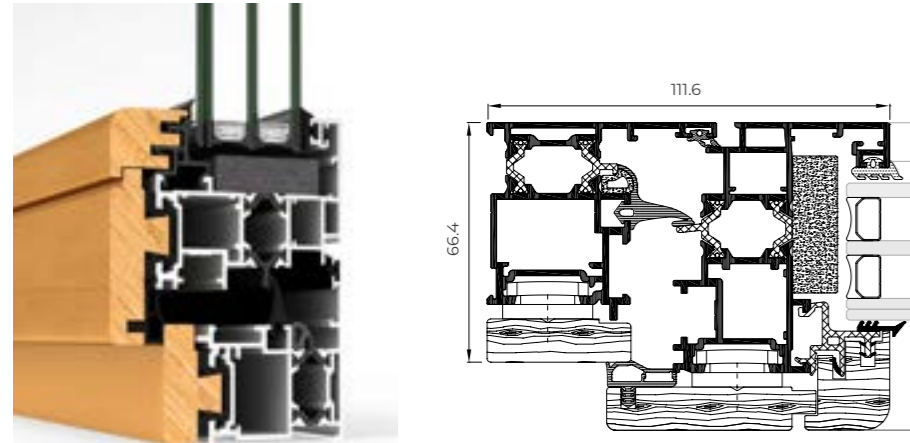

16 Groove
Thermally broken



POSSIBILITIES



FEATURES

Transmittance		$U_w \geq 1.1$ (W/m ² K)
Acoustic insulation		Rw up to 40 dB
Air permeability		Class 4
Watertightness		Class E1050
Wind resistance		Class C5

Reference test 1.23 x 1.48 m / 2 sashes

Sightlines

Frame 66.4 mm, Sash 85.3 mm

Polyamide Strip Length

Frame 14.8 mm

Sash 16 mm

Profile Thickness

Window 1.5 mm

Door 1.6 mm

Glazing

Sash: Max. 40 mm, Min. 18 mm

Fixed light: Max. 30 mm, Min. 8 mm

Maximum Sash Dimensions

Width (L) 1400 mm

Height (H) 2400 mm

Maximum Sash Weight

100 kg

Aesthetic possibilities:

Sash: Straight / Glazing Bead:

Curved

Consult maximum weight and dimensions according to typologies

OPENING POSSIBILITIES



Inward opening

Side hung
Tilt & turn
Tilt & parallel
Bottom hung







COR GALICIA PREMIUM C16



CASEMENT

Thermally broken window that allows for both side hung and top hung outward openings. This solution, with a thermal break zone of 32 mm and a transmittance U_w from 0.9 W/m^2K , has the British security certification PAS 24, being especially suitable for this market.

FEATURES

Transmittance		$U_w \geq 0.9 (W/m^2K)$
Acoustic insulation		Rw up to 45 dB
Air permeability		Class 4
Watertightness		Class E1200
Wind resistance		Class CE 2400
Security test	 	Passed

Reference test 1.44 x 1.33 m / 1 sash + 1 fixed light
Security test: Reference test 1.44 x 1.33 m / 1 sash + 1 fixed light

POSSIBILITIES



SECURITY HARDWARE



CONCEALED HINGES

OPENING POSSIBILITIES



Outward Opening

Side hung
Top hung

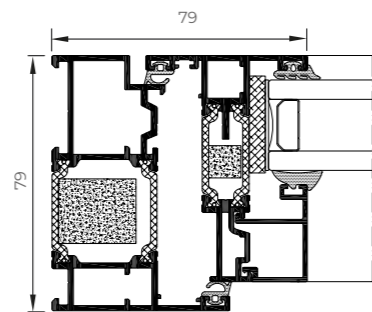

* Flush Version

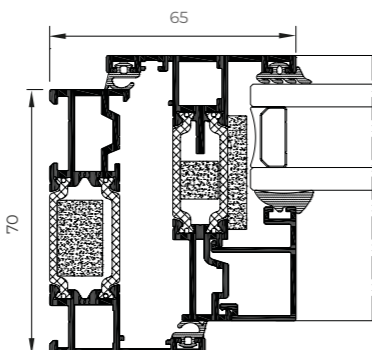

* Standard Version



Thermally broken

Sightlines

Frame 70 mm, Sash 70 mm

Polyamide Strip Length

32 mm

Profile Thickness

Window 1.6 mm

Glazing

Max. 44 mm, Min. 23 mm

Maximum Sash Dimensions

Slim Sash (Side Hung):

Width (L) 950 mm, Height (H) 1300 mm

Slim Sash (Top Hung):

Width (L) 1200 mm, Height (H) 1300 mm

Heavy Duty Sash (Side Hung):

Width (L) 750 mm, Height (H) 1750 mm

Heavy Duty Sash (Top Hung):

Width (L) 1800 mm, Height (H) 1800 mm

Maximum Sash Weight

Side Hung Slim Sash: 35 kg

Top Hung Slim Sash: 50 kg

Side Hung Heavy Duty Sash: 42 kg

Top Hung Heavy Duty Sash: 100 kg

Consult maximum weight and dimensions according to typologies



CASEMENT

contemporary
enclosures



door systems

Millennium Plus 80

DOOR

Flush entrance door system with straight lines, 80 mm of frame depth, and a thermal break zone of 34 mm, particularly suitable for commercial and residential buildings.

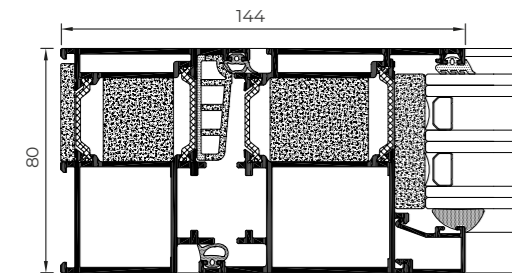

FEATURES

Transmittance		$U_D \geq 0.8$ (W/m ² K)
Acoustic insulation		Rw up to 40 dB
Air permeability		Class 4
Watertightness		Class 6A
Wind resistance		Class C4
Resistance to mild impact		Class 5 (Max.)
Repeated openings and closings		1,000,000 Cycles
Burglar resistance		Grade RC2

Wind resistance: Reference test 1.20 x 2.30 m / 1 sash
 Resistance to mild impact: EN 13049. Test on door reference 1.80 x 2.20 m / 2 sashes. Laminated glass 3+3
 Resistance to repeated openings and closings: EN 1191. Test on door reference 2.10 x 2.20 m / 1 sash
 Burglar test NEN 5096: 2012+A1: 2015 in EN 1627:201

Sightlines

Frame 80 mm, Sash 80 mm

Polyamide Strip Length

34 mm

Profile Thickness

Door 2.0 mm

Glazing

Max. 64 mm, Min. 15 mm

Maximum Sash Dimensions

Door:

Width (L) 1800 mm, Height (H) 3000 mm

Concealed door hinges:

Width (L) 1500 mm, Height (H) 3000 mm

Maximum Sash Weight

220 kg

Consult maximum weight and dimensions according to typologies



POSSIBILITIES



CONCEALED HINGES



ACCESSIBILITY



AUTOMATION

OPENING POSSIBILITIES

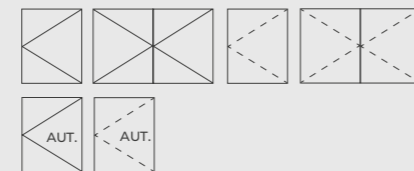

Inward Opening

Side hung

Outward opening

Side hung

Automatic Opening

Inward and outward side hung

Millennium Plus 70

DOOR

Flush entrance pedestrian door system with 70 mm of frame depth that guarantees high thermal and acoustic insulation.

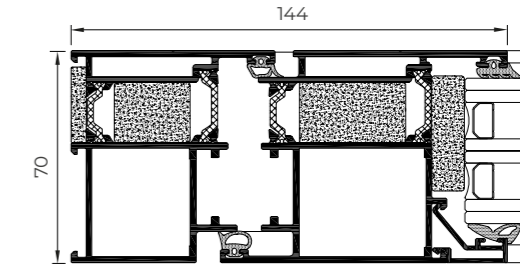

Sightlines

Frame 70 mm, Sash 70 mm

Polyamide Strip Length

24 mm

Profile Thickness

Door 2.0 mm

Glazing

Max. 54 mm, Min. 15 mm

Maximum Sash Dimensions

Door:

Width (L) 1800 mm, Height (H) 3000 mm

Concealed door hinges:

Width (L) 1500 mm, Height (H) 3000 mm

Maximum Sash Weight

220 kg

Consult maximum weight and dimensions according to typologies



OPENING POSSIBILITIES

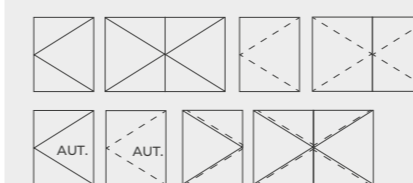

Inward Opening

Side hung

Outward opening

Side hung

Automatic Opening

Outward and inward side hung

Swing Opening

Side hung

FEATURES

Transmittance		$U_D \geq 0.9$ (W/m ² K)
Acoustic insulation		Rw up to 38 dB
Air permeability		Class 4
Watertightness		Class 6A
Wind resistance		Class C4
Resistance to mild impact		Class 5 (Max.)
Repeated opening and closings		1,000,000 cycles
Burglar resistance		Grade RC2

Wind resistance: Reference test 1.20 x 2.30 m / 1 sash
 Resistance to mild impact: EN 13049. Test on door reference 1.80 x 2.20 m / 2 sashes. Laminated glass 3+3
 Security test: EN 5096: 2012+A1: 2015 in EN 1627: 201
 Resistance to repeated openings and closings: EN 1191. Test on door reference 2.1 x 2.2 m / 2 sashes
 Burglar test NEN 5096: 2012+A1: 2015 in EN 1627:201

POSSIBILITIES



CONCEALED HINGES



ACCESSIBILITY



AUTOMATION



MILLENNIUM PLUS 80 DOOR

CONCEALED HINGES

The Millennium Plus door system allows **concealed hinges** that reinforce the flush aesthetic of the series



Millennium Plus Pivot DOOR

Doors

The new CORTIZO entrance door system, available in a paneled or glazed version, responds to the latest design trends. Thanks to its axes, it allows large pivot openings, becoming a cutting-edge solution for contemporary architecture. Safety and excellent thermal and acoustic performance are also protagonists in a system that completes CORTIZO's catalog of minimalist solutions.



Paneled version



Glazed version

FEATURES

Transmittance		$U_D \geq 0.77$ (W/m ² K)
Air permeability		Class 4
Watertightness		Class 5A
Wind resistance		Class C5

Reference test 1.20 x 2.00 m / 1 Sash

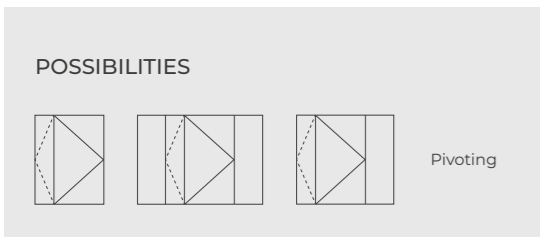

Pivoting

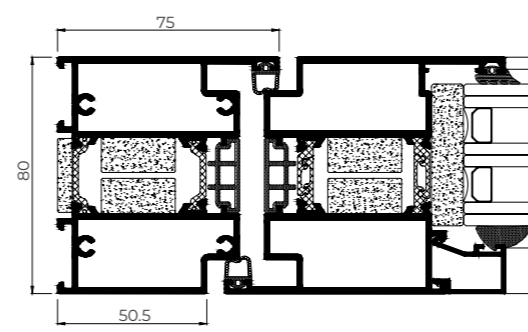
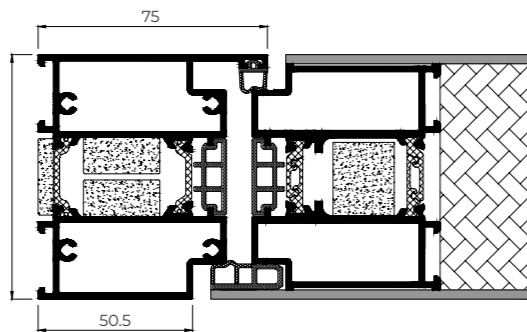

- Sightlines**
Frame 80 mm, Sash 80 mm
- Polyamide Strip Length**
24 / 26 mm
- Profile Thickness**
Door 2,0 mm
- Panel**
80 mm
- Maximum glazing**
64 mm
- Maximum Sash Dimensions**
Width (L) 2100 (1700* + 400) mm
Height (H) 3000 mm
- Maximum Sash Weight**
250 kg

Consult maximum weight and dimensions according to typologies
* Measured from the pivot axis

MILLENNIUM PLUS PIVOT DOOR



Panelled DOOR

Compatible with the Millennium Plus 80 and Millennium Plus 70 series, it incorporates a panel integrated into the sash, which allows a wide range of aesthetic possibilities. In addition, it allows for the installation of an embedded handle with led illumination and a scanner.

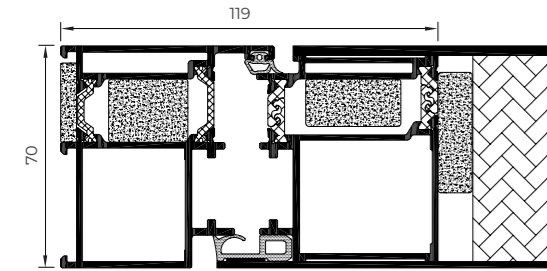

OPENING POSSIBILITIES

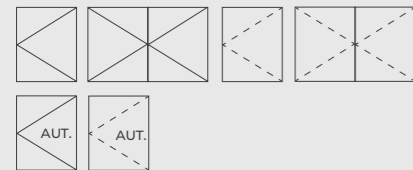

Inward Opening

Side hung

Automatic side hung

Outward Opening

Side hung

Automatic side hung

Wind resistance: Reference test 1.20 x 2.30 m / 1 sash
Resistance to mild impact: Test carried out according to standard EN 13049
Test on door reference 1.80 x 2.20 m / 2 sashes. Laminated glass 3+3
Resistance to repeated openings and closing: Test carried out according to standard EN 1191
Test on door reference 0.935 x 2.10 m / 1 sash

*Compatible with Millennium Plus 70 and 80 doors



Sightlines

Frame 80 / 70 mm, Sash 80 / 70 mm

Polyamide Strip Length

30 / 34 mm (80)

20 / 24 mm (70)

Profile Thickness

Door 2,0 mm

Panel

Max. 80 mm, Min. 33 mm (80)

Max. 70 mm, Min. 23 mm (70)

Maximum Sash Dimensions

Door:

Width (L) 1800 mm, Height (H) 3000 mm

Concealed door hinges:

Width (L) 1500 mm, Height (H) 2700 mm

Maximum Sash Weight

220 kg

120 Kg (concealed hinges)

Consult maximum weight and dimensions according to typologies

Doors



Millennium 2000

DOOR

Pedestrian door system for commercial and residential buildings that allows the incorporation of double or triple flag hinges of high strength, capable of supporting up to 180 kg. per sash.



Sightlines

Frame 45 mm, Sash 45 mm

Profile Thickness

Door 2.0 mm

Glazing

Max. 30 mm, Min. 3 mm

Maximum Sash Dimensions

Side hung:

Width (L) 1450 mm, Height (H) 3000 mm

Swing:

Width (L) 1100 mm, Height (H) 3000 mm

Maximum Sash Weight

180 kg

Consult maximum weight and dimensions according to typologies

Doors



POSSIBILITIES



ACCESSIBILITY

Aesthetic possibilities:

Sash: Straight / Bead: Straight or curved

FEATURES

Transmittance  $U_D \geq 2.3 (W/m^2K)$

Acoustic insulation  R_w up to 38 dB

Resistance to mild impact  Class 5 (Max.)

Test carried out according to standard UNE-EN 13059
Reference test 1.80 x 2.20 m / 2 sashes. Laminated glass 3+3

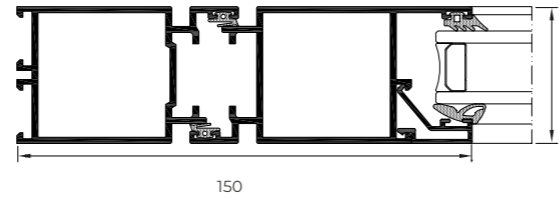

OPENING POSSIBILITIES

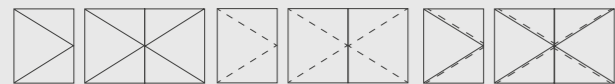

Inward opening

Side hung

Automatic side hung



Outward Opening

Side hung

Automatic side hung

Swing Opening

Side hung 1 and 2 sashes



MILLENNIUM 2000 DOOR



MILLENNIUM SLIDING AUTOMATIC DOOR

Millennium Sliding Automatic

DOOR

Door system with sliding sashes and automatic opening, designed to solve high traffic entrances (offices, shopping centres, hospitals..) since it guarantees fluidity of user's traffic and safety in emergency situations.

POSSIBILITIES



- Sightlines**
 Frame 45 mm
 Sash 45 mm (EC-drive engine)
 Sash 25 mm (Slimdrive engine)
 - Profile Thickness**
 Door 2.0 mm
 - Glazing**
 Max. 30 mm, Min. 3 mm
 - Maximum Sash Dimensions**
 Width (L) 2000 mm, Height (H) 3000 mm
 - Maximum Sash Weight**
 120 Kg
- Consult maximum weight and dimensions according to typologies

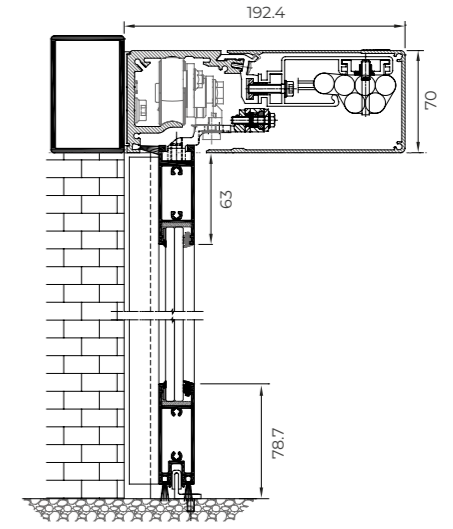

OPENING POSSIBILITIES







Automatic Opening
 Sliding 1 sash and 1 fixed light
 Sliding 2 sashes and 2 fixed lights

Bi-fold DOOR

Doors

Bi-fold door system with 73 mm of frame depth and optimal thermal and acoustic performances, ideal for moderate climates.

FEATURES

Transmittance		$U_D \geq 0.97$ (W/m ² K)
Air permeability		Class 4
Watertightness		Class 9A
Wind resistance		Class A3
Security test	 	Passed

Wind resistance: reference test 2.700 x 2.530 m / 3 sashes
Security test: Configuration 330. 2701 x 2517 mm / 3 sashes

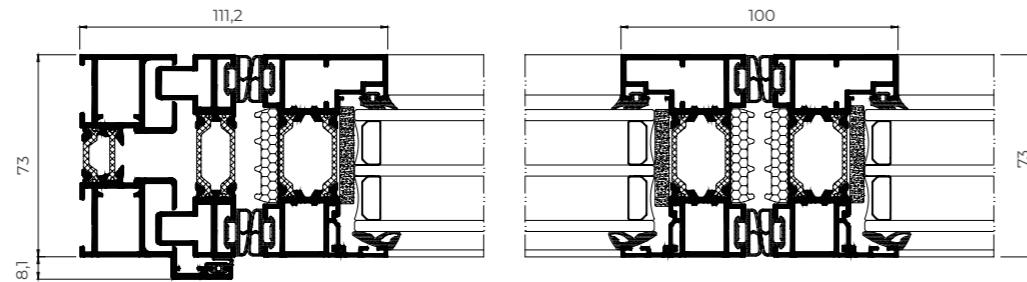

OPENING POSSIBILITIES

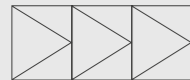

Inward
From 1 to 14 sashes

Outward

From 1 to 14 sashes
Possibility of corner sash at 90° without mullion

POSSIBILITIES



SECURITY
HARDWARE



ACCESSIBILITY

Sightlines

Frame 73 mm, Sash 73 mm

Polyamide Strip Length

Frame 20 mm
Sash 30 mm

Profile Thickness

Door 1.8 mm

Glazing

Max. 45 mm, Min. 25 mm

Maximum Sash Dimensions

Width (L) 1200 mm, Height (H) 3000 mm

Maximum Sash Weight

120 kg

Consult maximum weight and dimensions according to typologies









Bi-fold plus DOOR

Doors

Separate environments and unify spaces with this bi-fold door system with an 80 mm deep frame. This evolution of the Bi-fold series offers an excellent thermal and acoustic performance, thanks to its 45 mm thermal break and a glazing capacity up to 52 mm. Besides, it presents a slim central section of 110 mm which allows the maximisation of the glazed surface, filling the interior spaces with natural light.

FEATURES

Transmittance		$U_D \geq 0.78$ (W/m ² K)
Air permeability		Class 4
Watertightness		Class E750
Wind resistance		Class C3
Repeated openings and closings		50.000 cycles (Main swing door) 25.000 cycles (Even sashes)
Security test	 	Passed

Reference test 3.73 x 2.50 m, 3 sashes
Security test: 3 sashes reference test. Configuration 321.270 x 2.50 m
Resistance to repeated openings and closings: EN 1191, 3 sashes reference test. Configuration 321.3.73 x 2.50 m

OPENING POSSIBILITIES



Inward
Up to 14 sashes

Outward
Up to 14 sashes
90° corner sash without mullion

POSSIBILITIES



SECURITY
HARDWARE



ACCESSIBILITY

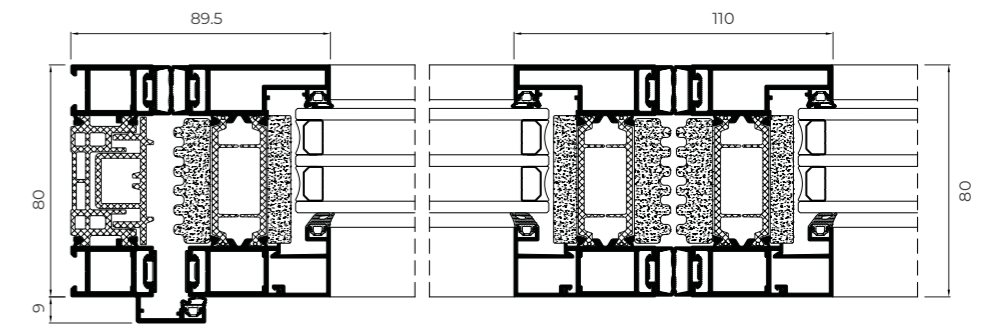

Sightlines

Frame 80 mm, Sash 80 mm

Polyamide Strip Length

Frame 45 mm
Sash 45 mm

Profile Thickness

Door 1.8 mm

Glazing

Max. 48 mm, Min. 25 mm

Maximum Sash Dimensions

Width (L) 1200 mm, Height (H) 3000 mm

Maximum Sash Weight

120 kg

Consult maximum weight and dimensions according to typologies





BI-FOLD PLUS DOOR

contemporary
enclosures







sliding window and door systems

COR VISION

Plus

The greatness of minimalism is reflected in this sliding system of large dimensions with sashes of up to 4 meters, interlock sightline of only 25 mm and frames embedded in the perimeter, allowing for a glazed surface of up to 94%. It has a maximum glazing capacity of 56 mm, offering excellent thermal and acoustic performances. Available with manual (up to 400 kg) or motorized (up to 700 kg) opening system. Additionally, accessibility is favoured by the possibility of hiding the rail and even integrating it fully into the floor.

FEATURES

Transmittance		$U_w \geq 0.9$ (W/m ² K)
Acoustic insulation		Rw up to 43 dB
Air permeability		Class 4
Watertightness		Class 7A* / 9A**
Wind resistance		Class C3* / C4**

Wind resistance:
 * Reference test balcony 4.00 x 3.00 m / 2 sashes
 ** Reference test balcony 4.00 x 3.00 m / 1 sash + 1 fixed light

OPENING POSSIBILITIES

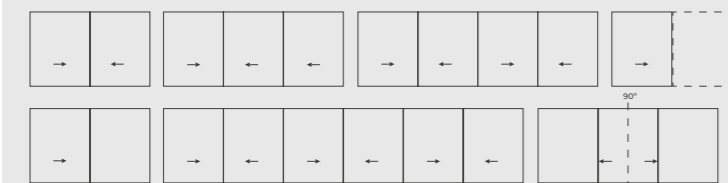

Sliding
 Possibility of 1, 2, 3 or 4 rails
 Possibility of inner and outer corner sash at 90° without mullion
 Pocket possibility

Sliding
 Thermally broken



Sightlines

Frame 180 mm / 278 mm 3 rails

Sash 69 mm

Polyamide Strip Length

Frame 40 mm

Sash 18 / 32 mm

Profile Thickness

Door 2.0 mm

Glazing

Max. 56 mm, Min. 36 mm

Maximum Sash Dimensions

Width (L) 4000 mm, Height (H) 4000 mm

*Glazed surface 14 m²

Maximum Sash Weight

400 kg Manual

700 Kg Motorized

Consult maximum weight and dimensions according to typologies

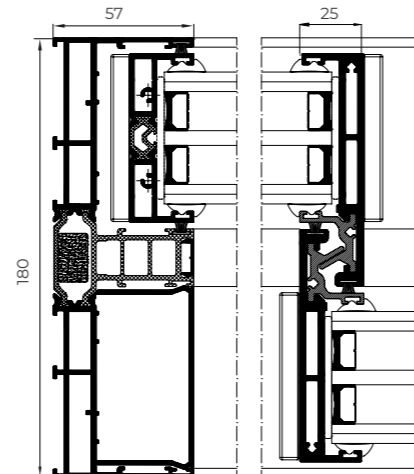

COR VISION PLUS



DRAINAGE SOLUTION



HIDDEN TRACK SOLUTION

Possibility of **embedding the bottom profile and integrate it within the floor finish** (pallet, pavement, ceramic...), achieving a transition without any obstacle between the interior and exterior of the room.



SECURITY HARDWARE

FLUSH SECURITY HARDWARE

MAXIMUM SECURITY

Locking system with internal and external key.
Embedding of the hardware into the profile with the same minimalist aesthetic.
Possibility of powder coating in any color to provide uniformity to the ensemble.

POSSIBILITIES



AUTOMATION



ACCESSIBILITY



HIDDEN SASH
Allows the concealment of the sashes in the lateral corners

INTERLOCK PROFILE
Only 25 mm

Option of **INTERLOCK HANDLE**

MAX. GLAZING
Up to 56 mm

LARGE DIMENSIONS
Up to 4000 mm of height or width / sash





UP TO 700 KG / Motorized
UP TO 400 KG / Manual

COR VISION PLUS

COR VISION EVOLUTION



The new version of the Cor Vision accentuates its minimalism thanks to a closing system that allows the sashes to be fully hidden within the frame, opening up to infinite views that are only interrupted by a 25 mm interlock.

FEATURES

Transmittance		$U_w \geq 0.88$ (W/m ² K)
Acoustic insulation		Rw up to 43 dB
Air permeability		Class 4
Watertightness		Class E900
Wind resistance		Class C3

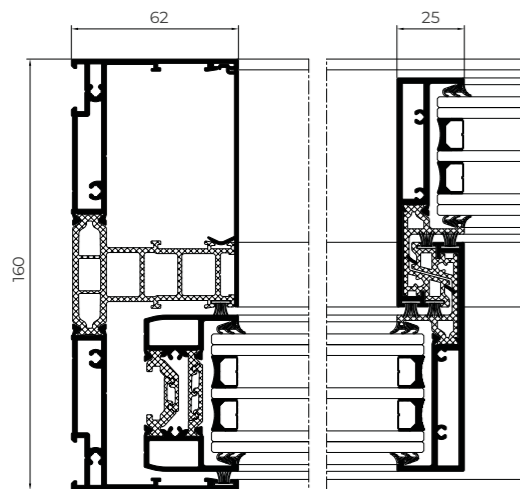
**Reference test 4.00 x 3.038 m / 2 sashes



Sliding 
Thermally broken 



Sightlines

Frame 160 mm / 248 mm 3 rail / 336 mm 4 rails
Lateral sightline 62 mm
Interlock 25 mm

Glazing

Max. 44 mm, Min. 28 mm

Maximum sash dimensions

Width (L) 3500 mm, Height (H) 3500 mm

Maximum sash weight

500 kg

Consult maximum weight and dimensions according to typologies

OPENING POSSIBILITIES

Sliding

Possibility of 1, 2, 3 and 4 rails

Possibility of inner and outer corner sash at 90° without mullion

Pocket possibility

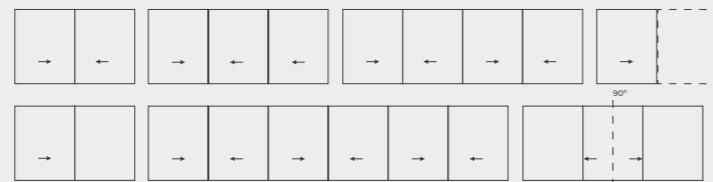

The new handle of the COR Vision Evolution is conceived to achieve total concealment of the sashes behind the frame, activating the opening and closing of the window with a smooth semicircular turn.

COR VISION

Thermally broken minimalist sliding system that provides maximum luminosity with a minimal aluminium interlock profile. It has an elegant design only 20 mm sightline and offers the possibility of an inlaid closing system and of hiding the frame along the perimeter.

Possibility of locking system in the interlock, thus allowing the concealment of the sashes in the frame from a frontal view.

Possibility of embedded locking system which facilitates the sashes crossing.

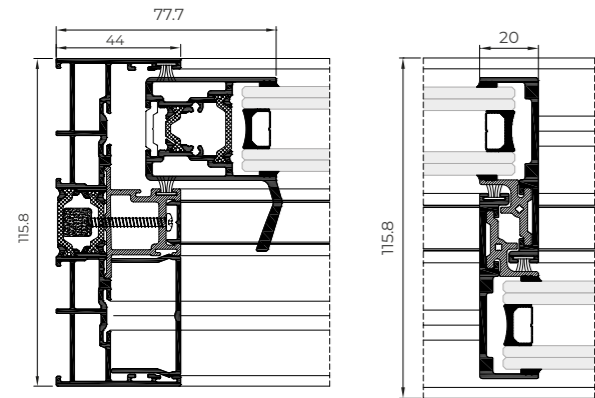

FEATURES

Transmittance		$U_w \geq 1.3 (W/m^2K)$
Acoustic insulation		Rw up to 41 dB
Air permeability		Class 4
Watertightness		Class 7A
Wind resistance		Class C5
Security test		Passed

Reference test 1.23 x 1.55 m / 1 sash + 1 fixed light

Sliding
Thermally broken



Sightlines

Frame 116 mm / 182 mm 3 rails

Sash 37 mm

Polyamide Strip Length

16 / 24 mm

Profile Thickness

Door 1.7 mm

Glazing

Max. 30 mm, Min. 26 mm

Maximum Sash Dimensions

Width (L) 2500 mm, Height (H) 3000 mm

Maximum Sash Weight

320 Kg

Consult maximum weight and dimensions according to typologies

POSSIBILITIES



OPENING POSSIBILITIES

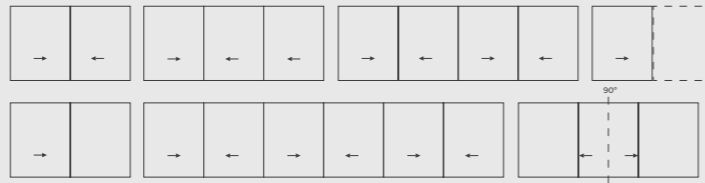

Sliding
Possibility of 1, 2 or 3 rails
Possibility of inner and outer corner at 90° without mullion
Pocket possibility

COR VISION







4600 PLUS

Lift & Slide

The new 4600 Plus Lift&Slide from Cortizo allows for the covering of large openings while ensuring exceptional thermal insulation. Its 80 mm deep sashes and special polyamides allow it to achieve a U_w transmittance of just 0,65 W/m^2K , establishing itself as one of the sliding systems with the best thermal performance on the market. Furthermore, the perimeter interlock profile is reduced to 120 mm, allowing for an increased glazed surface and enhancing the entry of natural light into the rooms.

Sliding
Thermally broken

FEATURES		
Transmittance		$U_w \geq 0.65 (W/m^2K)$
Acoustic insulation		Rw up to 43 dB
Air permeability		Class 4
Watertightness		Class E750*
Wind resistance		Class C5**

*Reference test 4.0 x 2.5 m / 1 sash + 1 fixed light
**Reference test 4.0 x 2.5 m / 2 sashes

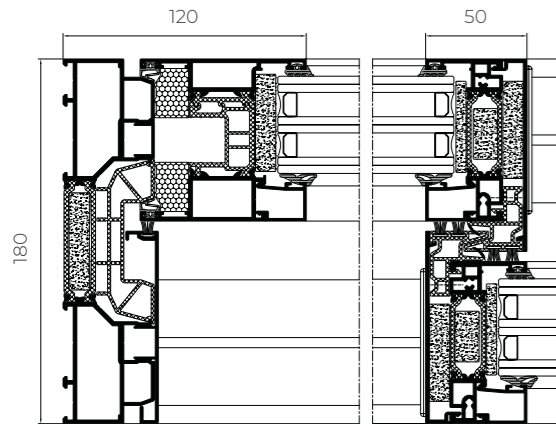

Sightlines

Frame 180 mm / 280 mm 3 rails /
380 mm 4 rails
Sash 80 mm

Glazing

Max. 65 mm, Min. 22 mm

Maximum Sash Dimensions

Width (L) 3300 mm, Height (H) 3500 mm

Maximum Sash Weight

400 kg

Consult maximum weight and dimensions according to typologies

OPENING POSSIBILITIES

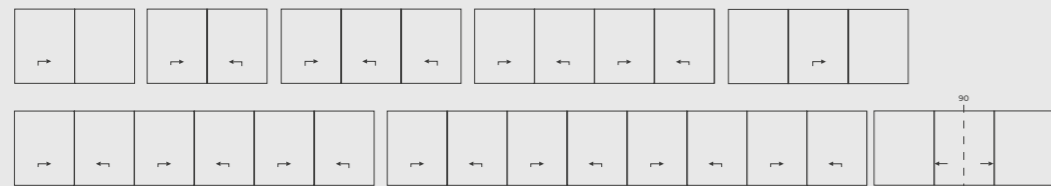

Sliding

1 rail (1 sash + 1 fixed light), 2, 3 & 4 rails
Possibility of 90° opening without mullion



4600 PLUS LIFT & SLIDE

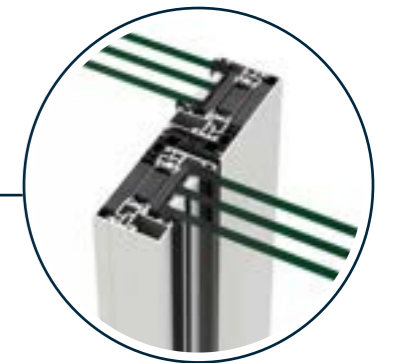

SLIM INTERLOCK

Possibility of a **reduced interlock section of 50 mm** in monorail frame (sash + fixed light) and 2 rail frame, allowing a larger glazed surface.

4700

In-line Slider / Lift & Slide

This sliding system, available both in-line slider and lift & slide versions, becomes an ideal solution for closing large spans. It presents modern aesthetics in straight lines, a reduced interlock section and large glazed surfaces that ensure bright and comfortable areas, due to its thermal and acoustic performance.

Sliding
Thermally broken



In-line Slider

Lift & Slide

FEATURES		
Transmittance		$U_w \geq 1,0$ (W/m ² K)
Acoustic insulation		Rw up to 40 dB
Air permeability		Class 3* / 4**
Watertightness		Class 7A
Wind resistance		Class C5* / C2**
Security test		Passed

* Reference in-line slider test 1,8 x 2,2 m / 2 sashes
 ** Reference lift & slide test 4,0 x 2,50 m / 2 sashes
 Security test: Reference test 2,40 x 2,40 m / 2 sashes

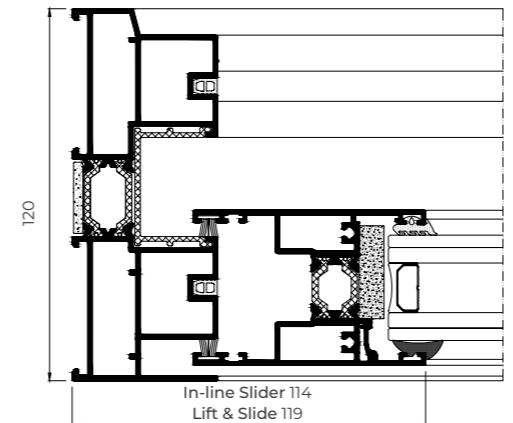
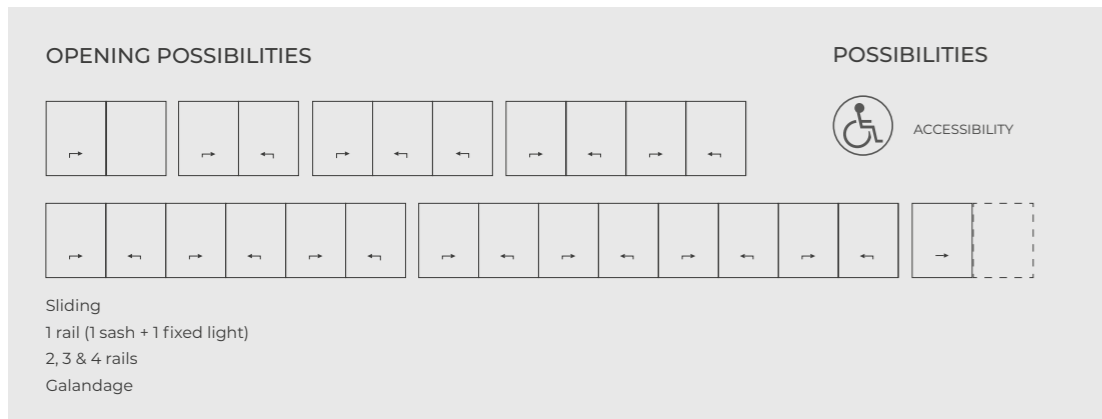

4700 SLIDING

- Sightlines**
 Frame 115 and 120 mm, 185 mm 3 rails
 Sash 50 mm
 - Polyamide Strip Length**
 20-25 mm
 - Profile Thickness**
 Balcony 1.5 mm
 - Glazing**
 Max. 36 mm, Min. 26 mm
 - Maximum Sash Dimensions**
 Width (L) 2500 mm, Height (H) 3000 mm
 - Maximum Sash Weight**
 In-line Slider 280 Kg
 Lift & Slide 300 Kg
- Consult maximum weight and dimensions according to typologies

4900 HI

Sliding

Standard sliding system with hinged features. Offers great thermal and acoustic performance favoured by a glazing capacity of up to 36 mm and a thermal break zone of 34 mm. It has an interlock section of 35 mm and straight lines, allowing the sashes to cross over thanks to the integrated handle with multilock system.

Sliding
Thermally broken



POSSIBILITIES



ACCESSIBILITY

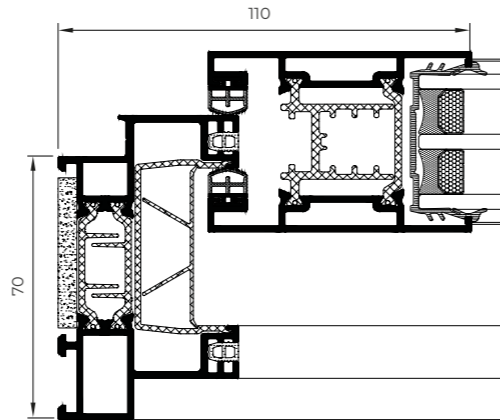

OPENING POSSIBILITIES



Sliding
1 rail (sash + fixed light)
2 and 3 rails
Pocket possibility
Possibility of 90° opening without mullion

FEATURES

Transmittance		$U_w \geq 1.2$ (W/m ² K)
Acoustic insulation		R _w up to 40 dB
Air permeability		Class 4
Watertightness		Class 7A
Wind resistance		Class C5

Reference test 1.80 x 2.20 m / 2 sashes
CSTB Laboratory DTA Certification

- Sightlines**
Frame 60, 70, 89, 120, 125, 130 mm
126, 145 mm 3 rails
201 mm 4 rails
Sash 48 mm
- Polyamide Strip Length**
34 mm
- Profile Thickness**
Window 1,6 mm
- Glazing**
Max. 36 mm, Min. 24 mm
- Maximum Sash Dimensions**
Width (L) 2200 mm
Height (H) 3000 mm
- Maximum Sash Weight**
240 kg

Consult maximum weight and dimensions according to typologies



4900 HI SLIDING

4200

Sliding

Standard sliding system with great versatility and straight or curved aesthetics, 45° or 90° sash encounters and various frames according to each configuration. The 45° and 90° sash encounter version allows the total opening of the span with the pocket possibility solution, completely concealing the sashes in the masonry wall's chamber. Furthermore, this version allows the integration of the solar protection Tamiz system on the same frame.

Sliding
Thermally broken



FEATURES

Transmittance		Uw ≥ 1.5 (W/m²K)
Acoustic insulation		Rw up to 39 dB
Air permeability		Class 3
Watertightness		Class 7A
Wind resistance		Class C5

Reference test 1.20 x 1.20 m / 2 sashes

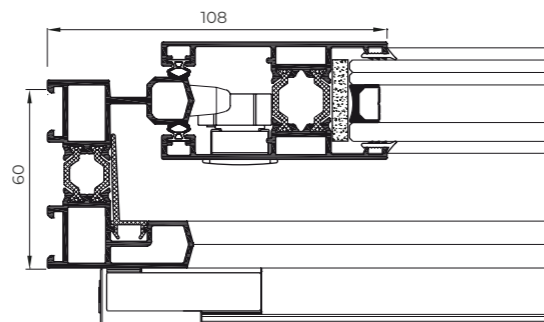

Sightlines
Frame 60 / 65 / 77 / 80 mm
106 / 126 mm 3 rails
Sash 33 / 37 mm
Polyamide Strip Length
From 14.6 - 20 mm
Profile Thickness
Window 1.5 mm
Glazing
Max. 26 mm, Min. 9 mm

Maximum Sash Dimensions
Width (L) 2200 mm
Height (H) 2600 mm
Maximum Sash Weight
100 Kg 45° sash encounter
200 Kg 90° sash encounter
Aesthetic possibilities:
Sash: Straight or curved
Bead: Straight or curved

Consult maximum weight and dimensions according to typologies

OPENING POSSIBILITIES

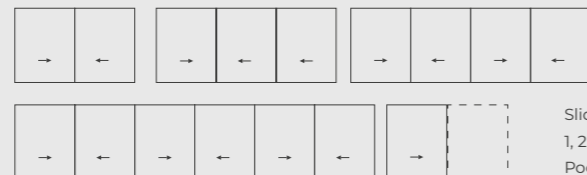

Sliding
1, 2 and 3 rails
Pocket possibility 1 and 2 rails



4200 SLIDING

5000

Double Sliding

Thermally broken double sliding window system with blind brackets inserted between the exterior and the interior sashes.

105

199

OPENING POSSIBILITIES

Sliding

FEATURES		
Transmittance		$U_w \geq 1.3$ (W/m ² K)
Acoustic insulation		Rw up to 40 dB
Air permeability		Class 3
Watertightness		Class 8A
Wind resistance		Class C5

Reference test 1.25 x 1.50 m / 2 sashes

Sightlines
 Frame 199 mm
 Sash 28 mm

Polyamide Strip Length
 16 and 24 mm

Profile Thickness
 Window 1.25 mm

Glazing
 Max. 18 mm, Min. 4 mm

Maximum Sash Dimensions
 Width (L) 1600 mm
 Height (H) 2600 mm

Maximum Sash Weight
 80 Kg

Consult maximum weight and dimensions according to typologies



Sliding
 Thermally broken



5000

Sliding / Integral Sliding

Sliding system that integrates the blind bracket into the lateral frame. Also available in standard version.

FEATURES		
Transmittance		$U_w \geq 2.3$ (W/m ² K)
Acoustic insulation		Rw up to 34 dB
Air permeability		Class 3
Watertightness		Class 8A
Wind resistance		Class C5

Reference test 1.20 x 1.20 m / 2 sashes

83

73

5000 Sliding

100

121

5000 Integral Sliding

Sightlines
 5000 Sliding: Frame 73 mm, Sash 28 mm
 5000 Integral Sliding: Frame 121 mm, Sash 28 mm

Profile Thickness
 Window 1.5 mm

Glazing
 Max. 18 mm, Min. 4 mm

OPENING POSSIBILITIES

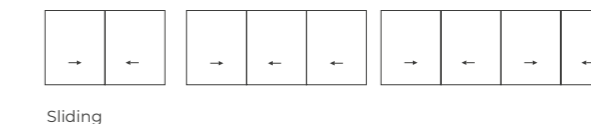

Maximum Sash Dimensions
 Width (L) 1600 mm
 Height (H) 2600 mm

Maximum Sash Weight
 80 Kg

Consult maximum weight and dimensions according to typologies

Sliding



MEDITERRANEAN

Balcony

Sliding balcony solution for mild climates with straight aesthetic and 45° sash and frame encounters.

Sliding

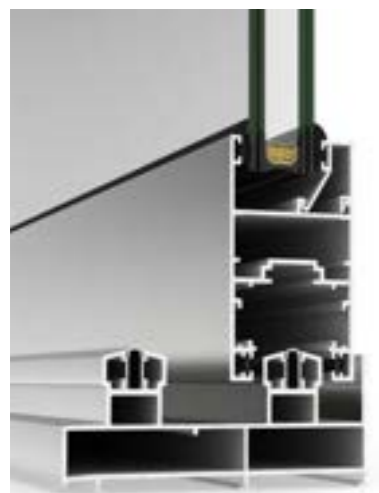

Sightlines

Frame 106 mm / 161 mm tricarril

Sash 45 mm

Profile Thickness

Balcony 1.5 mm

Glazing

Max. 30 mm, Min. 4 mm

Maximum Sash Dimensions

Width (L) 2200 mm

Height (H) 2600 mm

Maximum Sash Weight

240 Kg

Consult maximum weight and dimensions according to typologies

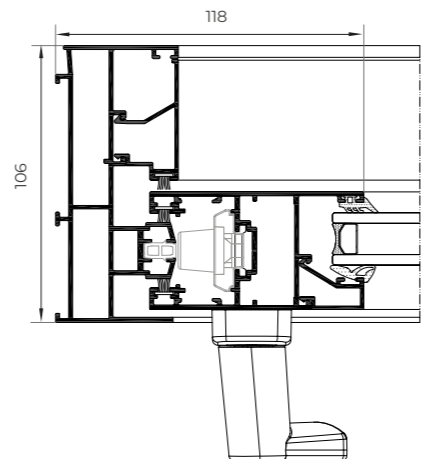

OPENING POSSIBILITIES



Sliding
1 rail (sash + fixed light), 2 and 3 rails
Pocket possibility

FEATURES

Transmittance  $U_w \geq 2.1$ (W/m²K)

Acoustic insulation  R_w up to 35 dB

Air permeability  Class 3

Watertightness  Class 8A

Wind resistance  Class C4

Reference test 1.49 x 1.24 m / 1 sash + 1 fixed light



MEDITERRANEAN BALCONY

2000

Perimetral Sliding

Perimetral sliding system with the possibility of straight, curved or chamfered sashes.



Sightlines

- Frame 40 mm 1 rail
- 40 / 45 / 60 / 70 mm 2 rails
- 80 mm 3 rails
- Straight and Chamfered sash 26 mm
- Curved sash 27.5 mm

Profile Thickness

Window 1.5 mm

Glazing

Max. 17 mm, Min. 3 mm

Maximum Sash Dimensions

Width (L) 1600 mm
Height (H) 2600 mm

Maximum Sash Weight

160 Kg

Consult maximum weight and dimensions according to typologies

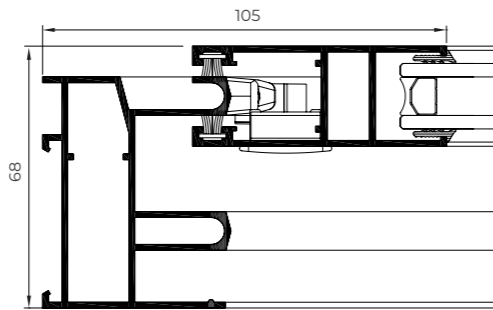

Aesthetic possibilities:

Sash: Straight, curved or chamfered
Glazing Bead: Straight or curved

FEATURES

Transmittance		$U_w \geq 2.9$ (W/m ² K)
Acoustic insulation		Rw up to 33 dB
Air permeability		Class 3
Watertightness		Class 8A
Wind resistance		Class C5

Reference test 1.20 x 1.20 m / 2 sashes

Sliding



6200

Sliding

Sliding system recommended for mild climates with a profile thickness of 1.25 mm and a glazing capacity of 15 mm.

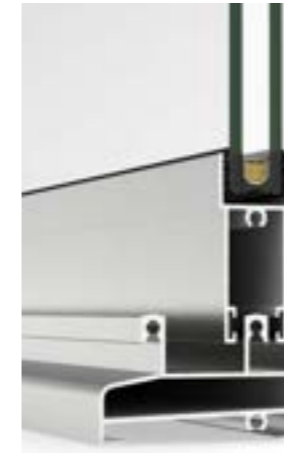

Sightlines

- Frame 60 mm
- Sash 22 mm

Profile Thickness

Window 1.25 mm

Glazing

Max. 15 mm, Min. 4 mm

Maximum Sash Dimensions

Window: Width (L) 800 mm, Height (H) 1600 mm
Balcony: Width (L) 800 mm, Height (H) 2100 mm

Maximum Sash Weight

80 Kg

Consult maximum weight and dimensions according to typologies

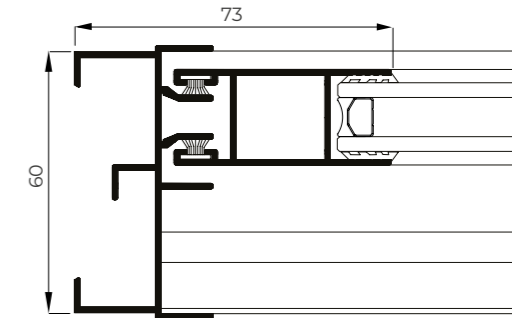

OPENING POSSIBILITIES

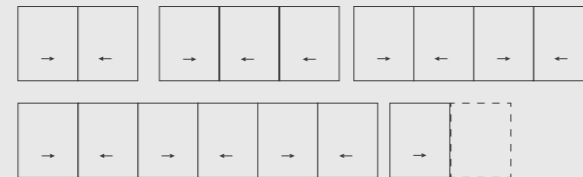

Sliding with 2, 3, 4 and 6 sashes
Possibility of 1 and 3 rails
Galandage possibility of 1 and 2 sashes

OPENING POSSIBILITIES

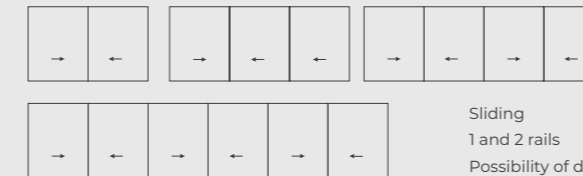

Sliding
1 and 2 rails
Possibility of double window

FEATURES

Transmittance		$U_w \geq 3.2$ (W/m ² K)
Acoustic insulation		Rw up to 35 dB
Air permeability		Class 3
Watertightness		Class 7A
Wind resistance		Class C3

Reference test 1.12 x 1.15 m / 2 sashes

Sliding



6500

Sliding

Sliding door and window system with an average profile thickness of 1.5 mm for undemanding climates.



Sightlines

Frame 83 mm

Sash 32 mm

Profile Thickness

Window 1.5 mm

Door 1.5 mm

Glazing

Max. 17 mm, Min. 4 mm

Maximum Sash Dimensions

Width (L) 1900 mm

Height (H) 2600 mm

Maximum Sash Weight

140 kg

Consult maximum weight and dimensions according to typologies

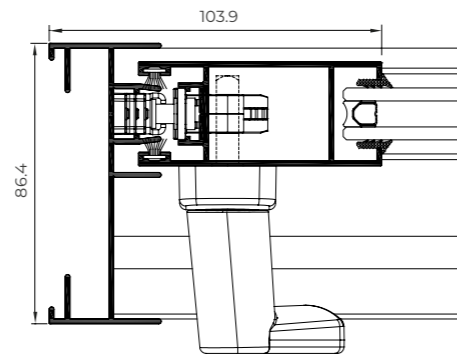

Sliding



OPENING POSSIBILITIES

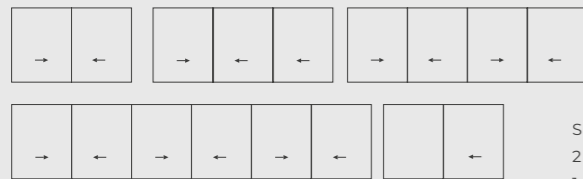

Sliding
2 and 3 rails
1 rail Pocket possibility

FEATURES

Transmittance $U_w \geq 2.2$ (W/m²K)

Acoustic insulation R_w up to 34 dB

Air permeability Class 3

Watertightness Class 7A

Wind resistance Class C4

Reference test 1.48 x 1.30 m / 2 sashes

6500

Plus Sliding

Window and door sliding system that allows an increase of the glazing capacity to up to 30 mm, thus improving the thermal and acoustic performance. Additionally, it has a interlock section of 40 mm that allows a larger glazed surface.

FEATURES

Transmittance $U_w \geq 2.0$ (W/m²K)

Acoustic insulation R_w up to 36 dB

Air permeability Class 3

Watertightness Class 7A

Wind resistance Class C4

Reference test 1.48 x 1.30 m / 2 sashes

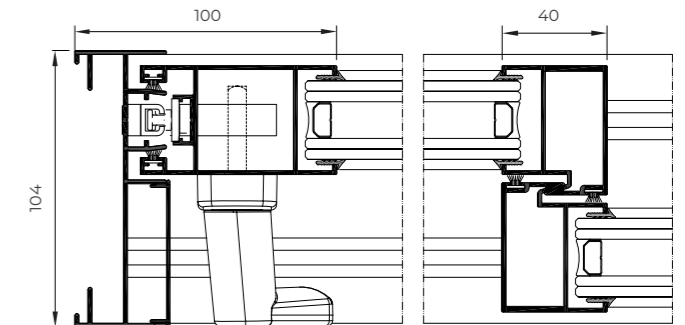

Sliding



Sightlines

Frame 104 mm / 158.1 mm (3 rails)

Sash 41.6 mm

Profile Thickness

Window 1.5 mm

Door 1.5 mm

Glazing

Max. 30 mm, Min. 18 mm

Maximum Sash Dimensions

Width (L) 1900 mm, Height (H) 2600 mm

Maximum Sash Weight

240 kg

Consult maximum weight and dimensions according to typologies

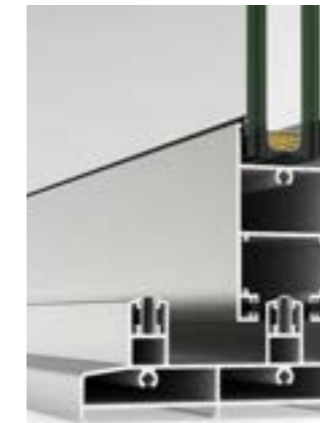

OPENING POSSIBILITIES

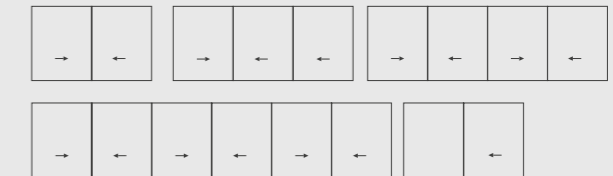

Sliding
1 rail (sash + fixed light), 2 and 3 rails

2000 PERIMETRAL SLIDING



6500 PLUS SLIDING



contemporary
enclosures



cortizo **PVC**

A 84

Passivhaus HI

Hinged system with 84 mm of frame depth and 6 interior chambers that offers the best thermal performance in the market, with a transmittance value U_w of only $0.66 \text{ W/m}^2\text{K}$. This series has been certified by the Passivhaus Institute for cool-temperate category (cold and temperate weather), becoming an ideal solution for low energy consumption buildings. It includes special insulating foams in the sash and frame, disposing of the steel reinforcement to increase transmittance. The glass itself acts as a structural element of the window, fixed to the profile by a special adhesive tape.

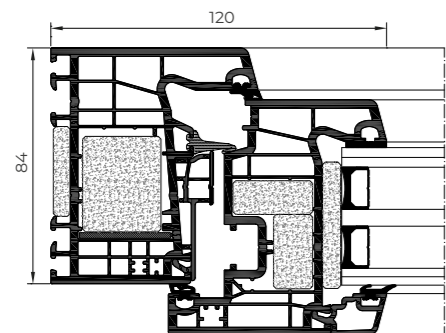

FEATURES

Transmittance		$U_w \geq 0.66 \text{ (W/m}^2\text{K)}$
Acoustic insulation		Rw up to 46 dB
Air permeability		Class 4
Watertightness		Class E1500
Wind resistance		Class C5

Reference test 1.23 x 1.48 m / 2 sashes

PVC



POSSIBILITIES



Sightlines

Frame 84 mm, Sash 84 mm

Glazing

Max. 56 mm, Min. 36 mm

Maximum Sash Dimensions

Window:

Width (L) 450-1300 mm

Height (H) 450-2200 mm

Maximum Sash Weight

Window: 130 kg

Consult maximum weight and dimensions according to typologies



Aesthetic possibilities:

Sash: Straight / Bead: Straight or curved

OPENING POSSIBILITIES



Inward Opening

Side hung
Tilt & turn
Bottom hung

A 84

Passivhaus 1.0 Thermally broken / Passivhaus 1.0

Certified for the warm-temperate category (warm-temperate weather), it offers a transmittance value U_w of $0.74 \text{ W/m}^2\text{K}$, thanks to the use of an internal reinforcement with thermal break.

FEATURES

Transmittance		$U_w \geq 0.74 \text{ (W/m}^2\text{K)}$
Acoustic insulation		Rw up to 46 dB
Air permeability		Class 4
Watertightness		Class E1500
Wind resistance		Class C5

Reference test 1.23 x 1.48 m / 2 sashes

Aesthetic possibilities:

Sash: Straight

Bead: Straight or curved

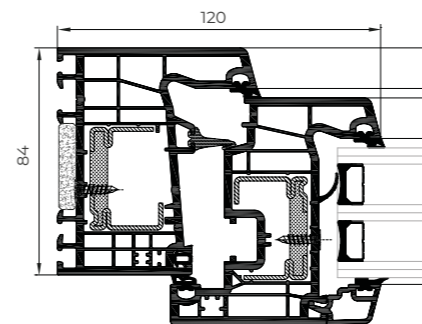

Passivhaus 1.0 Thermally broken

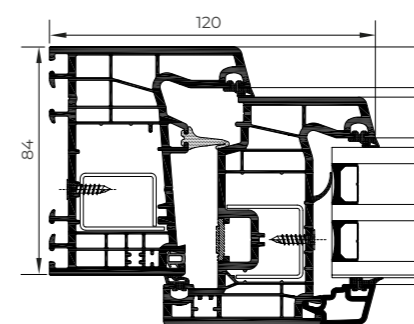

Passivhaus 1.0

POSSIBILITIES



OPENING POSSIBILITIES



Inward Opening

Side hung
Tilt & turn
Tilt & parallel
Bottom hung

Sightlines

Frame 84 mm, Sash 84 mm

Glazing

Max. 54 mm, Min. 18 mm

Maximum Sash Dimensions

Window:

Passivhaus 1.0 Thermally broken:

Width (L) 450-1400 mm

Passivhaus 1.0 reduced reinforcement:

Width (L) 450-1400 mm

Passivhaus 1.0 Thermally broken

Passivhaus 1.0 reduced reinforcement:

Height (H) 450-2400 mm

Balcony passivhaus 1.0:

Width (L) 450-1400 mm

Height (H) 600-2500 mm

Maximum Sash Weight

Window / Balcony: 150 kg

Consult maximum weight and dimensions according to typologies



A 84

Hinged

PVC



Hinged system with a 84 mm frame depth and 6 interior chambers with excellent thermal performance, U_w from 0.79 W/m^2K , and a great acoustic performance thanks to its glazing capacity of up to 54 mm.

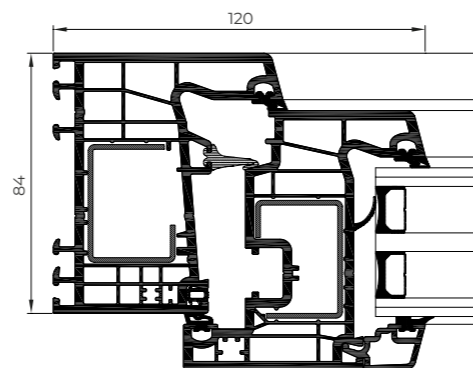

FEATURES

Transmittance		$U_w \geq 0.79 (W/m^2K)$
Acoustic insulation		Rw up to 46 dB
Air permeability		Class 4
Watertightness		Class E1500
Wind resistance		Class C5

Reference test 1.23 x 1.48 m / 2 sashes

Sightlines

Frame 84 mm

Sash 84 mm

Glazing

Max. 54 mm, Min. 4 mm

Maximum Sash Dimensions

Window:

Width (L) 450-1400 mm

Height (H) 450-2400mm

Balcony:

Width (L) 450-1400 mm

Height (H) 600-2500 mm

Door:

Width (L) 700-1300 mm

Height (H) ≤ 2500 mm

Maximum Sash Weight

150 Kg Window / Balcony

160 Kg Door

Aesthetic possibilities:

Sash: Straight

Bead: Straight or curved

Consult maximum weight and dimensions according to typologies

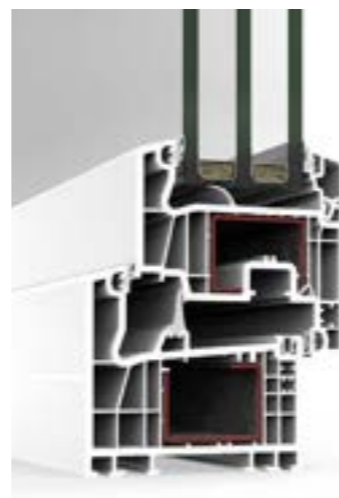

POSSIBILITIES



OPENING POSSIBILITIES



Inward Opening

Side hung
Tilt & turn
Tilt & parallel
Bottom hung

Outward Opening

Side hung (Door)

A 84 PASSIVHAUS



A 84 HIDDEN SASH

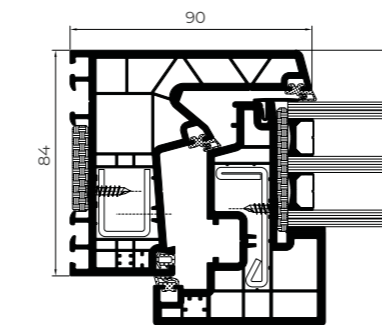

A 84 Hidden Sash Passivhaus 1.0

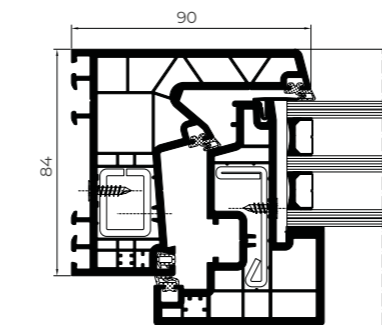

A 84 Hidden Sash

A 84

Hidden Sash Passivhaus 1.0 / Hidden Sash

Minimalist window with a lateral sightline of only 90 mm and possibility of reduced central sightline of the same measure. This system with 84 mm of frame depth and 6 interior chambers combines elegant design with excellent thermal performance, in the Passivhaus version certified for the warm-temperate category (U_w from 0.71 W/m^2K) as well as in the standard version (U_w from 0.74 W/m^2K).



A 84 Hidden Sash Passivhaus 1.0



A 84 Hidden Sash



Possibility of 90 mm interlock section



Sightlines

Frame 84 mm, Sash 84 mm

Glazing

Max. 46.5 mm, Min. 32 mm
Glazing: 46.5 mm (Passivhaus)

Maximum Sash Dimensions

Width (L) 400-1400 mm
Height (H) 450-2500 mm

Maximum Sash Weight

130 Kg Window / Balcony
Consult maximum weight and dimensions according to typologies

FEATURES

Transmittance Passivhaus		$U_w \geq 0.71 (W/m^2K)$
Transmittance Standard		$U_w \geq 0.74 (W/m^2K)$
Acoustic insulation		Rw up to 46 dB
Air permeability		Class 4
Watertightness		Class E2250
Wind resistance		Class C5

Reference test 1.23 x 1.48 m / 2 sashes

POSSIBILITIES

SECURITY HARDWARE
 CONCEALED HINGES
 ACCESSIBILITY (A 84 HIDDEN SASH)
 CONCEALED DRAINAGE (A 84 HIDDEN SASH)

OPENING POSSIBILITIES

Inward Opening
 Side hung
 Tilt & turn
 Bottom hung

A 78

Hinged / Passivhaus 1.0 Hinged

PVC window, door and balcony door system with straight-line aesthetics on the frame, sash and glazing beads (straight or mitre cut). It features excellent thermal and acoustic performance thanks to its 78 mm deep profiles with six chambers and a glazing capacity of up to 48 mm. This system also features new gaskets that improve the welding process at the profile joints. The Passivhaus version is an ideal solution for low-energy consumption homes.

PVC

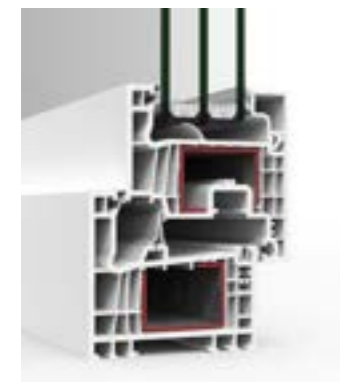

A 78 Hinged



A 78 Passivhaus 1.0 Hinged

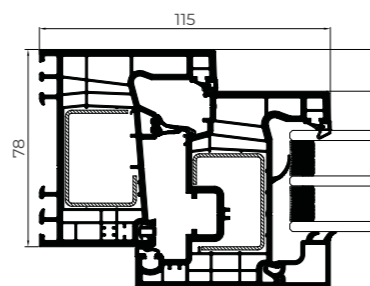

A 78 Hinged

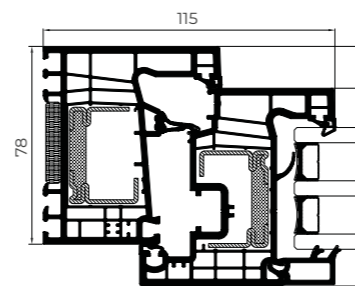

A 78 Passivhaus 1.0 Hinged

FEATURES

Transmittance Passivhaus		$U_w \geq 0.74$ (W/m ² K)
Transmittance		$U_w \geq 0.80$ (W/m ² K)
Acoustic insulation		R _w up to 46 dB
Air permeability		Class 4
Watertightness		Class E1800
Wind resistance		Class C5

Reference test 1.23 x 1.48 m / 2 sashes

POSSIBILITIES



OPENING POSSIBILITIES



Inward Opening

Side hung
Tilt & turn
Tilt & parallel
Bottom hung



A 78 HINGED

PVC

Sightlines

Frame 78 mm, Sash 78 mm

Glazing

Max. 48 mm

Maximum Sash Dimensions

Hinged

Window: Width (L) 400-1400 mm, Height (H) 450-2450 mm

Balcony door: Width (L) 400-1400 mm, Height (H) 600-2500 mm

Door: Width (L) 700-1300 mm, Height (H) 2500 mm

Passivhaus 1.0

Window: Width (L) 400-1400 mm, Height (H) 450-2200 mm

Balcony: Width (L) 400-1400 mm, Height (H) 600-2300 mm

Maximum Sash Weight

150 kg Window / Balcony door

160 Kg Door (Hinged)

Consult maximum weight and dimensions according to typologies

A 70

Hinged

Hinged system with 70 mm of frame depth with a maximum glazing capacity of 42 mm. The 5 interior chambers in the frame and sash allows for great energy efficiency with a transmittance value U_w from 0.9 W/m^2K . Possibility of straight, curved or chamfered sashes.

PVC



Straight Sash



Chamfered Sash



Curved Sash

Sightlines

Frame 70 mm
Sash 70 / 80 mm

Glazing

Max. 42 mm / Min. 4 mm

Maximum Sash Dimensions

Window:

Width (L) 360 - 1300 mm

Height (H) 450 - 2300 mm

Balcony:

Width (L) 360 - 1300 mm

Height (H) 600 - 2400 mm

Door:

Width (L) 700 - 1300 mm

Height (H) 600 - 2500 mm

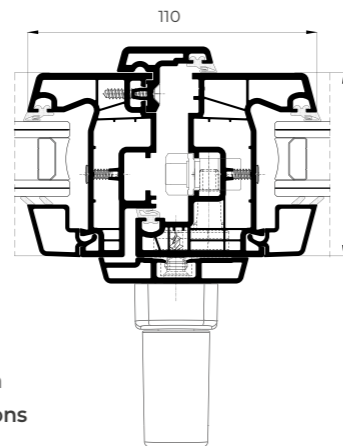

Possibility of centred handle

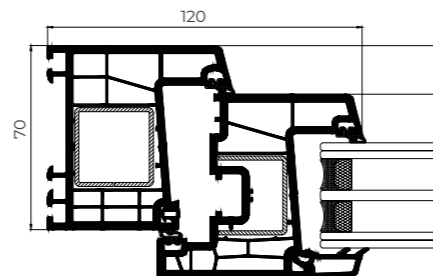

Maximum Sash Weight

130 kg Window

130 Kg Balcony

160 Kg Door

Aesthetic possibilities

Sash: Straight, curved or chamfered

Bead: Straight or curved

Consult maximum weight and dimensions according to typologies

OPENING POSSIBILITIES



Outward Opening

Side hung
Top hung

Inward Opening



Side hung

Tilt & turn
Bi-fold
Tilt & parallel
Bottom hung

POSSIBILITIES



SECURITY
HARDWARE



ACCESSIBILITY



CONCEALED
DRAINAGE

FEATURES

Transmittance $U_w \geq 0.9 (W/m^2K)$

Acoustic insulation R_w up to 46 dB

Air permeability Class 4

Watertightness Class E1800

Wind resistance Class C5

Reference test 1.23 x 1.48 m / 2 sashes
CSTB Laboratory DTA Certification

A 70 HINGED

PVC

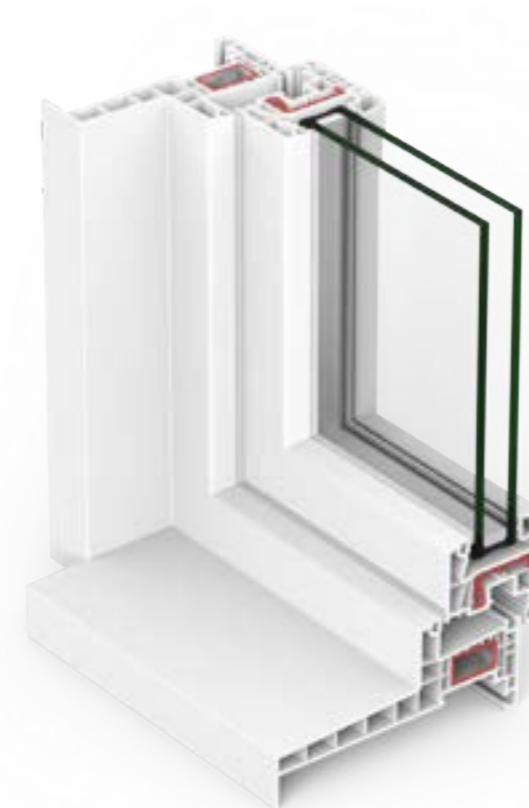

Monoblock

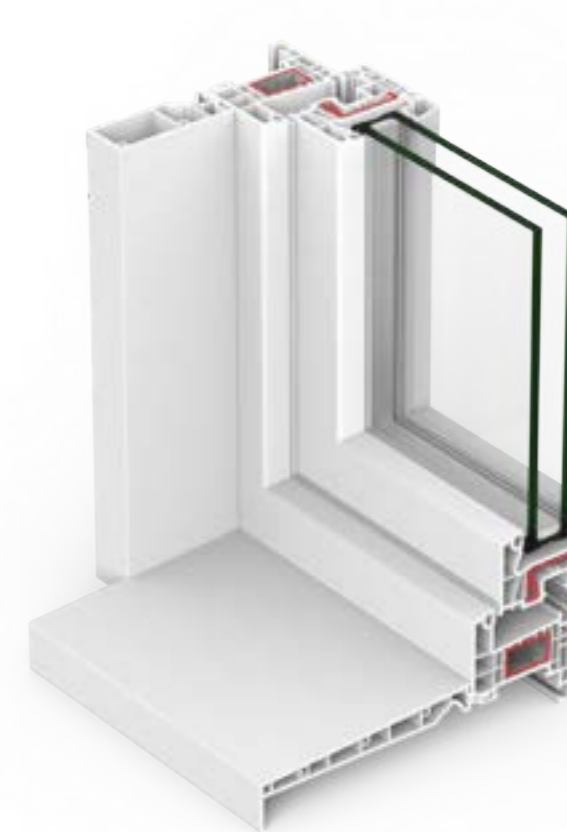

Cap

CORTIZO QUALITY PVC

Class A
Main walls thickness:
3 mm



Class S
Climatic zones
7 parts of titanium dioxide.
Maximum resistance to solar incidence



Class II
Impact resistance
Maximum profile hardness

A 70 HINGED



ALCOVER

PVC



Mixed window system that multiplies the aesthetic possibilities of the PVC A 70 series, covering the external face of the window with an aluminium profile clipped on the frame and sash, with 45° or 90° profile encounters.

This solution, ideal for rehabilitation, allows the combination of the excellent performance of PVC systems and the great variety of powder-coated and anodized finishes aluminium offers.

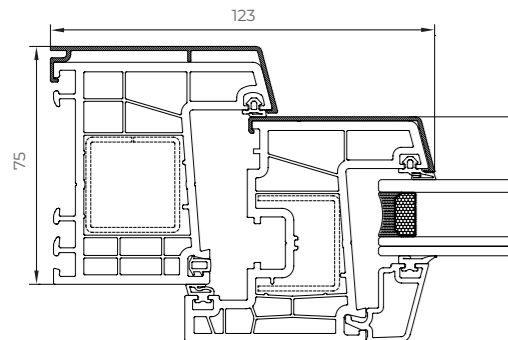

POSSIBILITIES



SECURITY
HARDWARE



Alcover 45° profile encounters



Alcover 90° profile encounters

OPENING POSSIBILITIES



Inward opening
Side hung
Tilt & turn
Bottom hung

FEATURES

Transmittance		$U_w \geq 0.9 (W/m^2K)$
Acoustic insulation		Rw up to 46 dB
Air permeability		Class 4
Watertightness		Class E1800
Wind resistance		Class C5

Reference test 1.23 x 1.48 m / 2 sashes

Sightlines

Frame 75 mm, Sash 71 mm

Glazing

Max. 42 mm, Min. 18 mm

Maximum Sash Dimensions

Window:

Width (L) 360 - 1300 mm

Height (H) 450 - 2300 mm

Balcony:

Width (L) 360 - 1300 mm

Height (H) 600 - 2400 mm

Maximum Sash Weight

130 kg Window

130 Kg Balcony

Consult maximum weight and dimensions according to typologies



PVC



C 70

Sliding

Sliding window and balcony system with 70 mm of frame depth and optimal thermal and acoustic performances. Possibility of minimalist sash with only 30 mm of interlock profile.

PVC



FEATURES

Transmittance		$U_w \geq 1.3$ (W/m ² K)
Acoustic insulation		Rw up to 38 dB
Air permeability		Class 4
Watertightness		Class 7A
Wind resistance		Class C5

Reference test 1.23 x 1.48 m / 2 sashes

POSSIBILITIES



SECURITY
HARDWARE



ACCESSIBILITY

OPENING POSSIBILITIES



Sliding

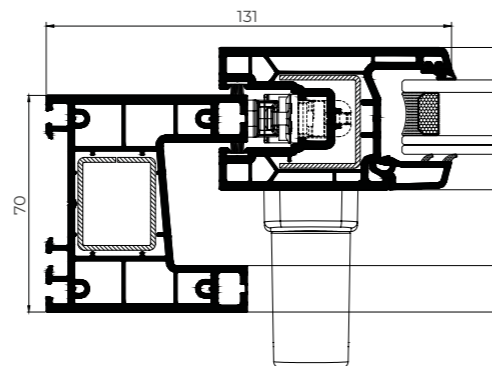

Sightlines

Frame 70 mm, Sash 46 mm

Glazing

Max. 28 mm, Min. 4 mm

Maximum Sash Dimensions

Window:

Width (L) 1400 mm

Height (H) 1800 mm

Balcony:

Width (L) 1800 mm

Height (H) 2600 mm

Maximum Sash Weight

70 kg Window

200 Kg Balcony

Consult maximum weight and dimensions according to typologies

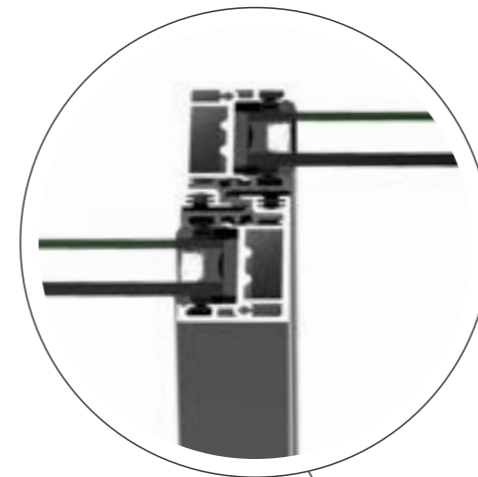

SLIM CENTRAL SECTION

Possibility of slim central section of 30 mm

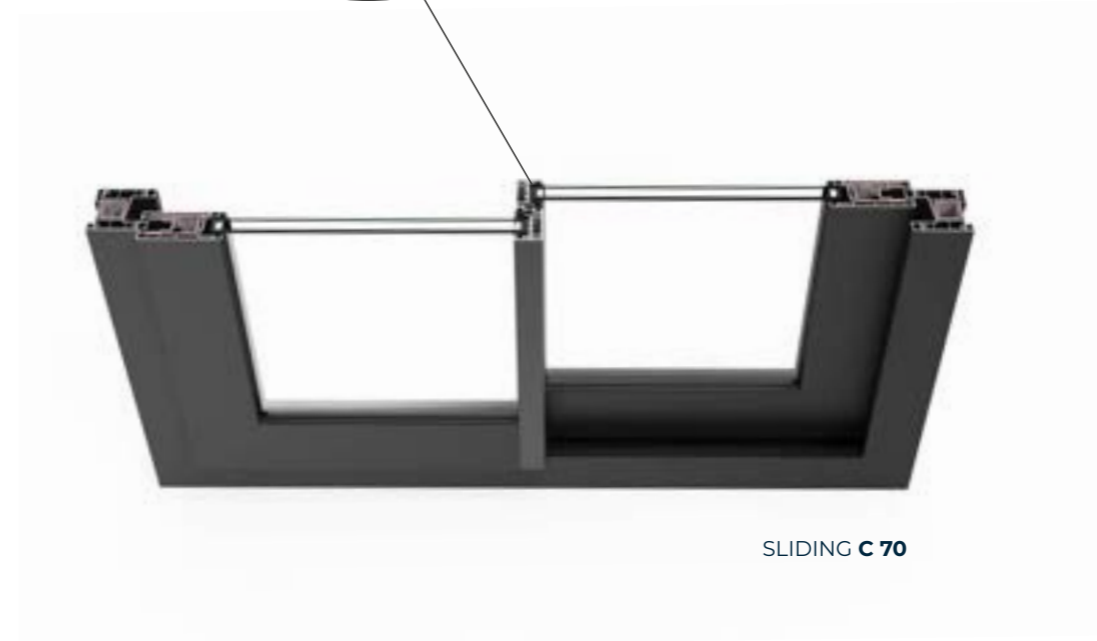
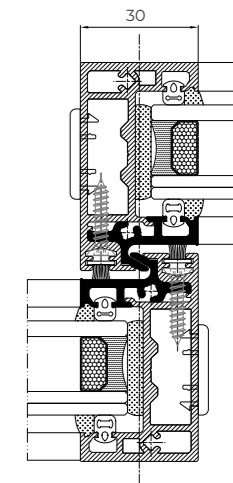

SLIDING C 70

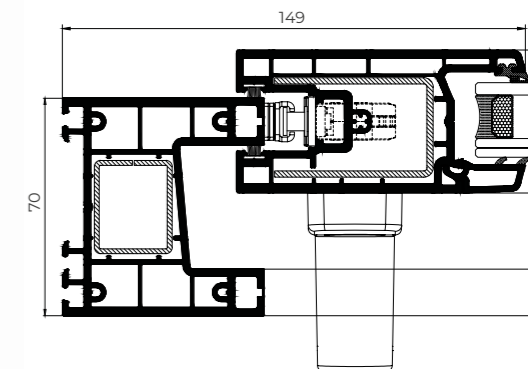

E 170

Lift & Slide

Designed for large span enclosures with sashes of up to 3 m wide and 2.80 m high. It includes a hardware system that slightly elevates the sash when the handle is operated, facilitating its movement in the opening and closing motions. This system has a frame depth of 170 mm and a maximum glazing capacity of 40 mm, offering remarkable thermal and acoustic performances.



Sightlines

Frame 170 mm, Sash 70 mm

Glazing

Max. 40 mm, Min. 18 mm

Maximum Sash Dimensions

Width (L) 3300 mm, Height (H) 2800 mm

Maximum Sash Weight

300 kg

Consult maximum weight and dimensions according to typologies

FEATURES

Transmittance		$U_w \geq 0.9 (W/m^2K)$
Acoustic insulation		Rw up to 42 dB
Air permeability		Class 4
Watertightness		Class 7A

Reference test 3.5 x 2.5 m / 1 sash + 1 fixed light

PVC

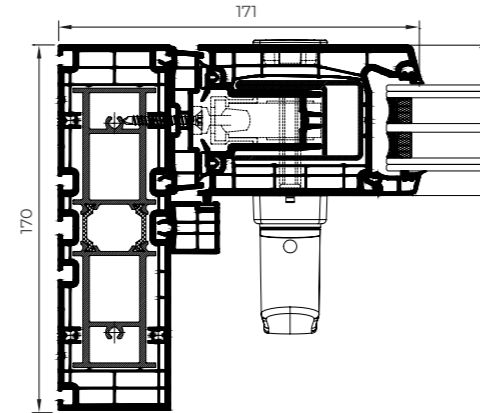

POSSIBILITIES



SECURITY
HARDWARE

OPENING POSSIBILITIES



Lift & slide system of 1, 2 and 4 sashes

E 170 LIFT & SLIDE



E 170

Lift & Slide

Designed for large span enclosures, this series evolves in its design towards a minimalist aesthetic where the perimeter sightline of the sash has been reduced and it features an interlock of only 50 mm. Additionally, it incorporates new solutions, such as the PRM threshold to facilitate accessibility, and the water collection channel for terraces.

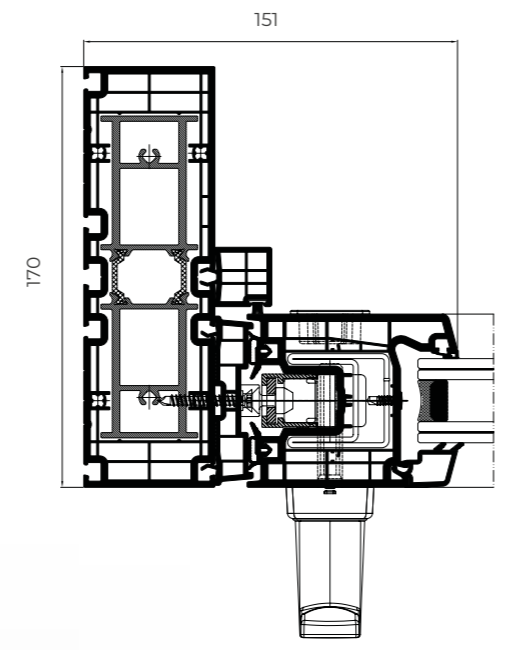

CORTIZO ISOLATION

Roller Shutter Box

This system, exclusive to all CORTIZO PVC series, offers the best thermal insulation in the market with a transmittance value U_{sb} from $0.66 \text{ W/m}^2\text{K}$, rounding off the catalogue of enclosure systems for zero-energy buildings. Additionally, it offers excellent acoustic performance with a noise attenuation of up to 44 db, and an elegant design with maximum quality materials and accessories.

FEATURES

Air permeability		Class 4
Watertightness		Class E2400
Wind resistance		Class 3000 Pa (P3)

Reference test 200 x 230 mm (height x depth) and 1230 mm length
Reference test 160 x 180 mm (height x depth) and 1230 mm length



ROLLER SHUTTER BOX 200 mm

Transmittance  $U_{sb} \geq 0.66 \text{ (W/m}^2\text{K)}$

Acoustic insulation  Rw up to 44 dB

Reference test 200 x 230 mm (height x depth) and 1230 mm length



ROLLER SHUTTER BOX 160 mm

Transmittance  $U_{sb} \geq 0.97 \text{ (W/m}^2\text{K)}$

Acoustic insulation  Rw up to 47 dB

Reference test 160 x 180 mm (height x depth) and 1230 mm length



Frontal Register



Bottom Register

Register options (roller shutter box 200 mm) Frontal, Bottom

Register options (roller shutter box 160 mm) Frontal

Maximum dimensions (roller shutter box 200 mm)

Width (L) 2400 mm (3800 mm with divider)

Height (H) 2600 mm (2800 mm with centred side frame)

Maximum dimensions (roller shutter box 160 mm)

Width (L) 2400 mm (3800 mm with divider)

Height (H) 1710 mm

Versatility

Possibility of using roller shutters with profiled, extrusion, or self-locking extrusion louvres.

Possibility of motorised or manual roller shutters activated by belt or cardan.

Possibility of integrated mosquito net.

Check maximum weight and dimensions according to typologies



Profile junction

Provided with a hidden sealing gasket

Registered and exclusive water-tightness system [®]



Connection profile in aluminium

Longitudinal Stability



Thermal insulation



Thermal-acoustic insulation



Lateral Connection Link Rod

Longitudinal Stability

CASSONETTO

Renovation Shutter Box

Cortizo Cassonetto renovation shutter box, consisting of PVC-U finishing profiles and specific panels for the access cover, has been designed to improve the integration of roller shutter systems with the window in renovation and new construction projects.

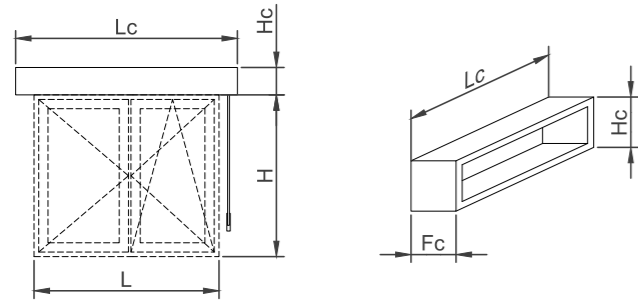

RENOVATION SHUTTER BOX LIMITS (mm)	Lc (min)	Lc (max)	Fc (max)	Hc (max)
Renovation shutter box with louvre (Ref.: 1480-1)	600	3600	300	300
Renovation shutter box with PS24 sandwich panel	600	3600	300	500
Renovation shutter box with P10 solid panel	600	3600	300	500

contemporary
enclosures



façade systems



Cortizo Technological Campus is a breeding ground for innovation created with the aim of becoming an international benchmark in the design of aluminium façades for worldwide large-scale architectural projects. There, a multidisciplinary team of 250 engineers, architects and technical architects will carry out their activity, focusing on the design of high-value added envelopes to meet the global demand for sustainable architecture.



_ Cortizo Technological Campus
Spain

DESIGN

Development of bespoke profiles, preparation of details and on-site installations. Calculation and sizing of profiles, Widthing, accessories, composite panels, and glazing. 3D visualisation and rendering.



PERFORMANCE

The tests carried out at CORTIZO's Technological Campus allow for the assessment of the façades performance against the most extreme conditions: earthquakes, hurricanes, fires... Additionally, in this laboratory, the thermal and acoustic performance of all developed systems is also tested, as well as their behaviour in air, watertightness and wind tests

COMPREHENSIVE ASSISTANCE

85 engineers provide the necessary technical assistance at every stage of the project, from the initial design phase, calculations, and pricing, to planning and delivery control.

UNIT 66

MODULAR FAÇADE

Thermally broken façade system suitable for high rise enclosure projects. This solution combines excellent performance with a wide range of custom designs, offering great aesthetic versatility with option of "glass only" or "seen profile" with an interlock profile of 66 mm. Its fixing bracket has three-dimensional regulation, facilitating its installation.

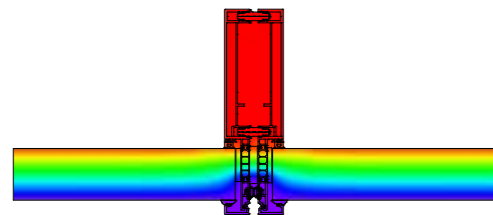

FEATURES

Transmittance		$U_{cw} \geq 0.6 (W/m^2K)$
Air permeability		Class AE
Watertightness		Class REI200
Wind resistance *		Passed
Impact resistance		I5 / E5

* Design loading 2000 Pa-Security loading 3000 Pa

OPENING POSSIBILITIES

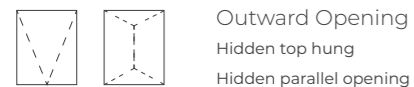

Façades



Maximum weight: 350 kg
Glazing: 58 mm
Interlock profile: 66 mm or 76 mm
Thermal break zone: 25 mm - 40 mm
Separation between modules: 10 or 20 mm
Maximum dimensions: Width (L) 1500 mm, Height (H) 3700 mm



Beaded version

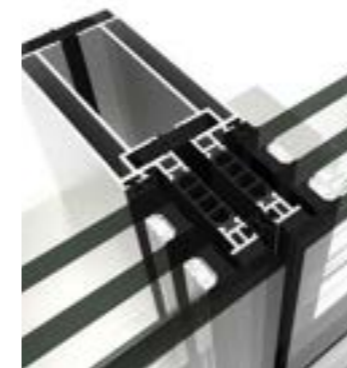

Structural version

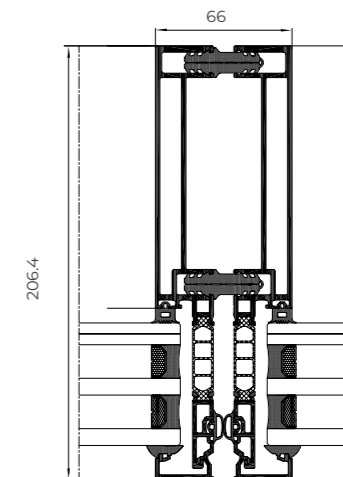

Standard version

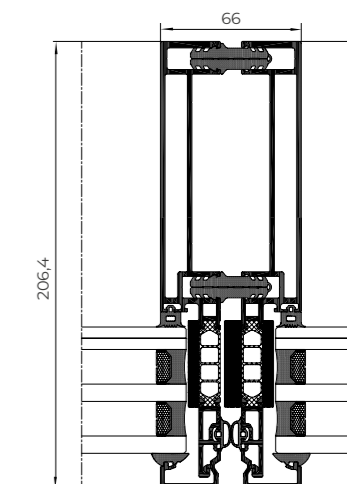

High insulation version

FAÇADES

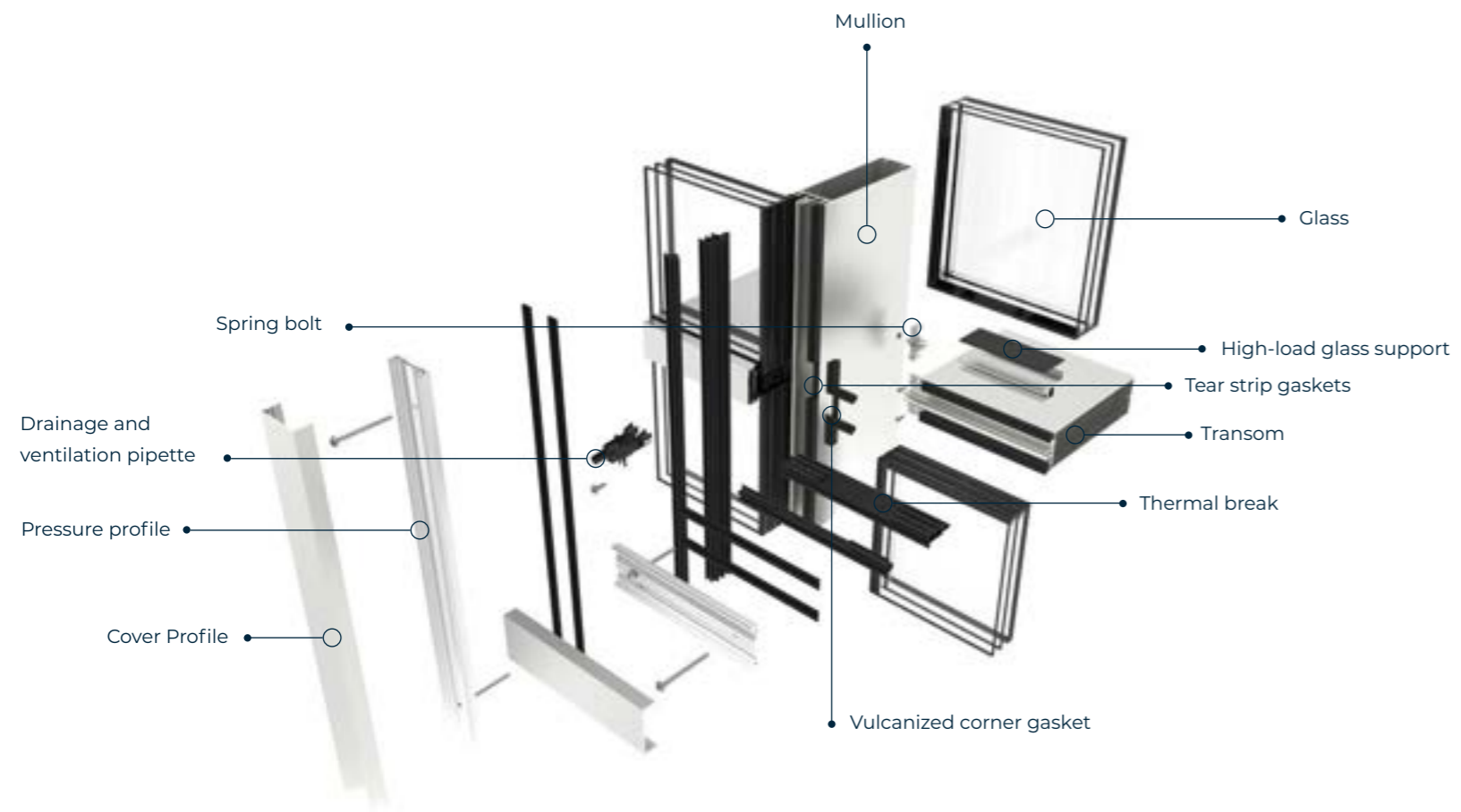

STICK 62 FAÇADES

CORTIZO extends its stick façades catalogue, adding new versions with mullions and transoms of 62 mm for the systems TP, TPH, TPV and SG. This range of curtain walls uses profiles which offer more inertia and allow the installation of bigger and heavier glasses, improving their fixation against potential movements of the structure. The 62 mm CORTIZO façades also present stronger unions between mullions and transoms, as well as an Widthring designed for tolerating bigger weight and wind loads than the 52 mm versions.



WATER-TIGHTNESS ELEMENTS

Two plastic accessories are used to guide the water from possible condensation towards the exterior:

Continuity piece

It carries the water that descends from the upper mullion's drainage channels over to the one immediately below in the fillet zone between them.

Pipette

Collects the water from the mullion's (and, generally, from the annexed transoms') drainage channels and expels it into the space between the pressor and the cover, away from the areas that are affected by Watertightness. Suitable for the TP 52 and TPV 52 systems.

In order to ensure Watertightness in the mullion-transom meeting points, CORTIZO façades offer two solutions:

Tear strip gaskets

Located inside the mullion with a crease that enables partial tearing in the meeting point with the transom, without leaving the union of the horizontal and vertical profile unprotected.

Vulcanized corner gasket

This piece is obtained through moulding, which allows the integration of the gaskets of different mullion and transom thickness and, at the same time, isolates the contact zone of the vertical and horizontal profiles.



Continuity piece



Pipette



Tear strip gaskets



Totally vulcanized corner

DRAINAGE LEVELS

CORTIZO façades have been designed so that the drainage channels of mullions and transoms of different levels are found in different planes. By doing this, the possible condensations will be led from the transoms' outer channels to the mullions and, from there, towards the exterior through the continuity pieces and the pipettes.

These same channels are used, simultaneously, to internally ventilate the four sides of the glass.



ARCH
INVISIBLE
FACADES

New handle embedded into the profile

Minimalist design invisible from the frontal view.

Available for top hung and parallel openings in the CORTIZO façade systems TP, TPH, TPV, SG of 52 and 62 mm.

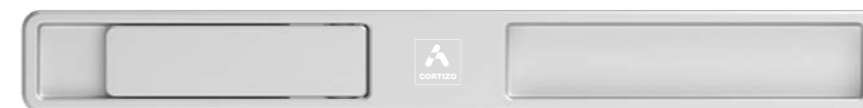



TP 52 FAÇADE

TP 52 FAÇADE

Light façade system composed of 52 mm mullions and transoms that form the support structure. The glass is fixed at its four sides by a continuous pressure profile that is externally screwed to the screw ports incorporated in the mullions and transoms, concealing the entire fixing system under an embellishing profile or cover with an interlock profile of 52 mm.

FEATURES

Transmittance		$U_{cw} \geq 0.6 (W/m^2K)$
Air permeability		Class AE
Watertightness		Class RE1350
Wind resistance *		Passed

Reference test 3,00 x 3,50 m
 Certification CWCT British Standard
 * Design loading 2000 Pa-Security loading 3000 Pa

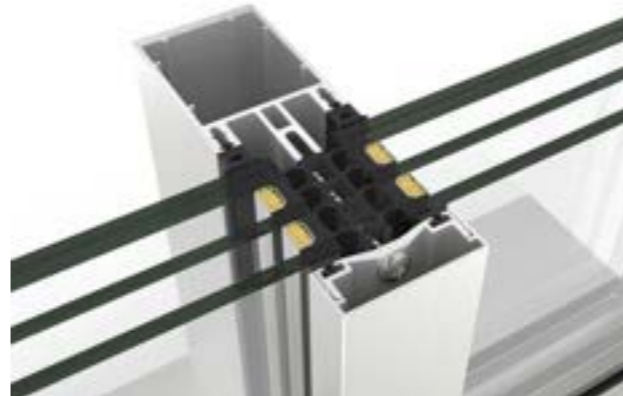

Glazing

Max. 64 mm, Min. 4 mm

Sightlines

Mullion 52 mm
 Transom 52 mm

Profile Thickness

Mullion 2.1 and 3.0 mm
 Transom 2,1 mm

Thermal Break Zone

6, 12 and 30 mm stackable profiles

Cover

85 mm deep elliptical cover
 H shape cover, 34 mm deep
 Rectangular cover: 14, 19 100 & 145 mm deep
 Flat cover
 Pyramid shape cover, 155 mm deep

Minimum / Maximum opening dimensions

Hidden Top Hung:

Width (L) 2500 - 500 mm, Height (H) 2500 - 650 mm

Hidden Side Hung / Tilt & Turn:

Width (L) 1400-500 mm, Height (H) 1900-600 mm

Hidden Parallel:

Width (L) 1500-450 mm, Height (H) 3000-650 mm

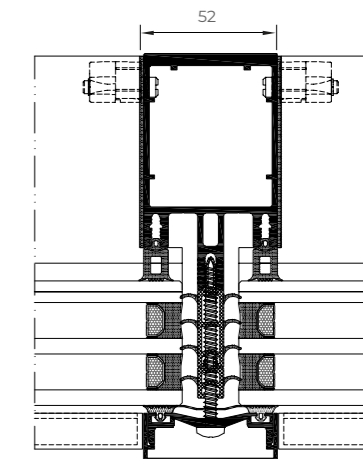

OPENING POSSIBILITIES



Outward Opening

Hidden top hung
 Hidden parallel

Inward Opening

Hidden side hung / tilt & turn





Maximum Weight

200 kg Parallel opening
 180 kg Hidden top hung opening
 100 Kg Tilt & turn opening
 750 Kg Fixed glazing

SG 52 FAÇADE

Curtain wall system with a glass only external aesthetic, this glass is fixed to the supporting profiles by a combination of clips and a U profile fitted into the glazing chamber.

FEATURES

Transmittance		$U_{cw} \geq 0.6 (W/m^2K)$
Air permeability		Class AE
Watertightness		Class RE1500
Wind resistance *		Passed

Reference test 3,00 x 3,50 m
 Certification CWCT British Standard
 * Design loading 2000 Pa-Security loading 3000 Pa

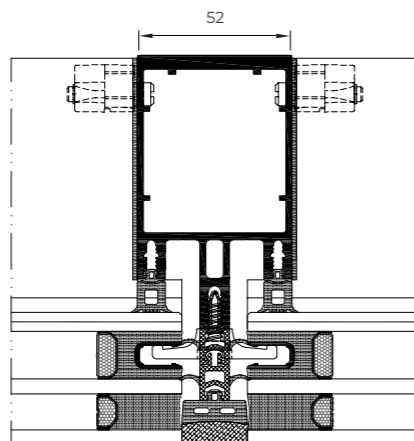

Glazing
 Max. 64 mm, Min. 6 mm

Sightlines
 Mullion 52 mm
 Transom 52 mm

Profile Thickness
 Mullion 2,1 and 3,0 mm
 Transom 2,1 mm

Thermal break zone
 6, 12 and 30 mm stackable profiles

Façades



Minimum / Maximum opening dimensions

Maximum Width (L) 2500 mm
 Minimum Width (L) 500 mm
 Maximum Height (H) 2500 mm
 Maximum Height (H) 650 mm

Maximum Weight

180 kg Hidden top hung opening
 750 Kg Fixed lights

OPENING POSSIBILITIES



Outward Opening
 Hidden Top Hung

SG 52 FAÇADE





TPH 52 FAÇADE

Façade solution based on the combination of the TP 52 and SG 52 systems. The glass is fixed by the pairing of the pressure profile and the cover profile on the horizontal gaskets, and it uses clips and the U-profile for its vertical edge.



OPENING POSSIBILITIES



Outward Opening
Hidden Top Hung

FEATURES

Transmittance		$U_{cw} \geq 0,6 (W/m^2K)$
Air permeability		Class AE
Watertightness		Class RE1500
Wind resistance *		Passed

Reference test 3,00 x 3,50 m
Certification CWCT British Standard
* Design loading 2000 Pa-Security loading 3000 Pa

Glazing

Max. 64 mm, Min. 6 mm

Sightlines

Mullion 52 mm

Transom 52 mm

Profile Thickness

Mullion 2,1 and 3,0 mm

Transom 2,1 mm

Covers

Flat cover

Rectangular cover: 14, 19 100 & 145 mm deep

H shape cover, 34 mm deep

85 mm deep elliptical cover

Minimum / Maximum opening dimensions

Hidden Top Hung:

Maximum Width (L) 2500 mm

Minimum Width (L) 500 mm

Maximum Height (H) 2500 mm

Minimum Height (H) 650 mm

Maximum Weight

180 kg Hidden top hung opening



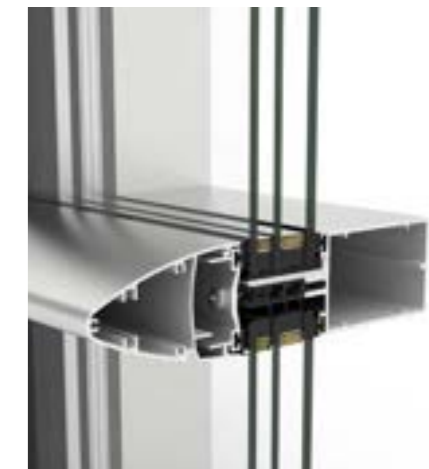
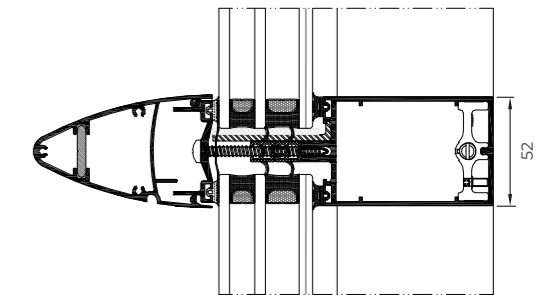

750 Kg Fixed lights



TPV 52 FAÇADE

Curtain wall system based on the combination of the TP 52 and SG 52 systems. The glass is fixed by the pairing of the pressure profile and the cover profile on its vertical edge, and it uses clips and the U-profile for the horizontal gaskets.

FEATURES

Transmittance		$U_{cw} \geq 0,6 (W/m^2K)$
Air permeability		Class AE
Watertightness		Class RE1500
Wind resistance *		Passed

Reference test 3,00 x 3,50 m
 Certification CWCT British Standard
 * Design loading 2000 Pa-Security loading 3000 Pa

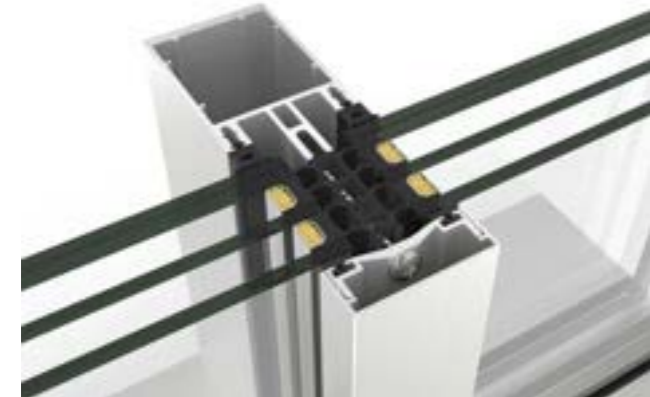

Glazing

Max. 64 mm, Min. 6 mm

Sightlines

Mullion 52 mm

Transom 52 mm

Thermal Break Zone

6, 12 and 30 mm stackable profiles

Profile Thickness

2,1 and 3,0 mm

2,1 mm

Covers

Flat cover

H shape cover, 34 mm deep

Rectangular cover: 14, 19 100 & 145 mm deep

Maximum Weight

180 kg Hidden top hung opening

750 Kg Fixed lights

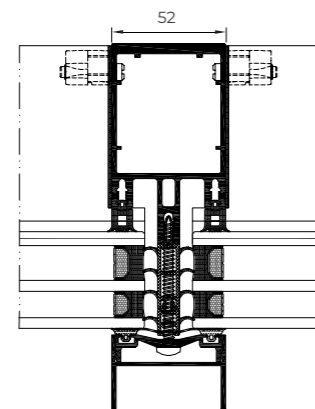

Façades



Minimum / Maximum opening dimensions

Top Hung Opening

Max. Width (L) 2500 mm, Min. Width (L) 500 mm

Max. Height (H) 2500 mm, Min. Height (H) 650 mm



OPENING POSSIBILITIES



Outward Opening

Hidden Top Hung



TPV 52 FAÇADE

ST 52 FAÇADE

In this façade system, the glass is glued with structural silicone to an aluminium frame, which is then glued to the main structure. It has an open groove glass only external aesthetic with EPDM gaskets in the perimeter of each module in order to guarantee Watertightness. An overlap closes the space between the gaskets.

OPENING POSSIBILITIES



Outward Opening
Hidden Top Hung



Glazing

Max. 38 mm, Min. 6 mm

Sightlines

Mullion 52 mm

Transom 52 mm

Profile Thickness

Mullion 2,1 and 3,0 mm

Transom 2,1 mm

Maximum Weight

180 kg Top hung opening

350 Kg Fixed lights

Minimum / Maximum opening dimensions

Top Hung Opening

Max. width (L) 2500 mm, Min. width (L) 500 mm

Max. height (H) 2500 mm, Min. height (H) 650 mm

FEATURES

Transmittance  $U_{cw} \geq 0,7$ (W/m²K)

Air permeability  Class AE

Watertightness  Class RE750

Wind resistance *  Passed

Reference test 3,00 x 3,50 m
Certification CWCT British Standard

* Design loading 2000 Pa-Security loading 3000 Pa

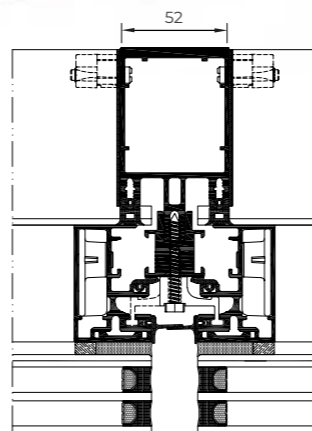

Façades

SST 52 FAÇADE

The glass is mechanically fixed to the aluminium frame with an external embellishing profile without the need of structural silicone as is the case in the TP 52 system. It also has an open groove external aesthetic, in this case by covering the glass with aluminium. The EPDM gasket is installed in the perimeter of each module, acting as a Watertightness first line of defence. An overlap closes the space between the gaskets.

FEATURES

Transmittance  $U_{cw} \geq 0,8$ (W/m²K)

Air permeability  Class AE

Watertightness  Class RE750

Wind resistance *  Passed

Reference test 3,00 x 3,50 m
Certification CWCT British Standard

* Design loading 1200 Pa-Security loading 1800 Pa

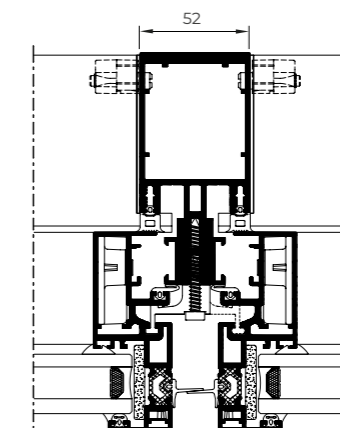

Glazing

Max. 28 mm, Min. 6 mm

Sightlines

Mullion 52 mm

Transom 52 mm

Thermal Break Zone

18 mm

Profile Thickness

Mullion 2,1 and 3,0 mm

Transom 2,1 mm

Maximum Weight

180 kg Top hung opening

350 Kg Fixed lights

Minimum / Maximum opening dimensions

Max. width (L) 2500 mm, Min. width (L) 500 mm

Max. height (H) 2500 mm, Min. height (H) 650 mm

OPENING POSSIBILITIES



Outward Opening
Hidden Top Hung

Façades

ST 52 FAÇADE



SST 52 FAÇADE



EQUITY FAÇADE

This system is characterised by a slim and minimalistic aesthetic with an interlock profile of only 18 mm both in mullions and transoms, which are also the same depth. This creates a flush mounting that provides the façade a uniform aesthetic. The glazing of this curtain wall is compatible with the TP 52, TPH 52, TPV 52 and SG 52 series.

Transmittance  $U_{cw} \geq 0.6 (W/m^2K)$

Glazing

Max. 64 mm, Min. 4 mm

Sightlines

Mullion 18 mm

Transom 18 mm

Profile Thickness

2.6 mm (Mullion and Transom)

Covers

Flat cover

85 mm deep elliptical cover

H shape cover, 34 mm deep

Rectangular cover: 14, 19 100 & 145 mm deep

Pyramid shape cover, 155 mm deep

6, 12 & 30 mm stackable thermal break profiles

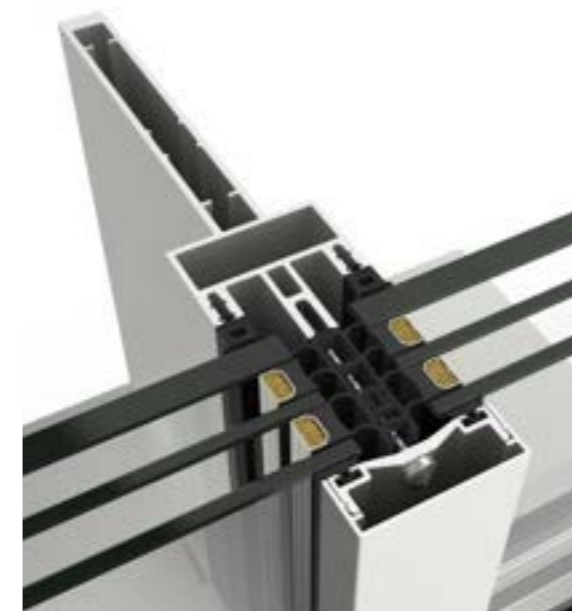
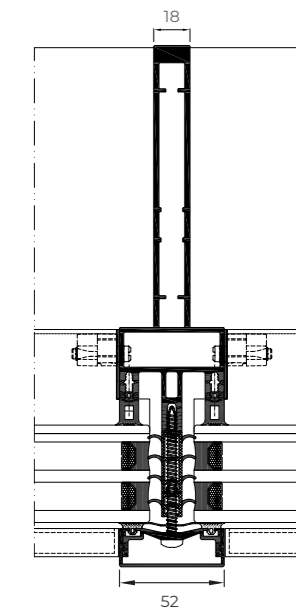



VERANDA

Gable or hipped roofing system comprised of flush mullions and transoms for 1st, 2nd, and 3rd level that allow for different drainage levels, guaranteeing perfect outflow of water, ventilation and Watertightness.

Possibility of motorized top hung opening in roof areas.
This skylight system allows for an easy integration of our veranda systems, our hinged windows or our sliding window/door systems.

OPENING POSSIBILITIES



Outward opening
Motorized top hung

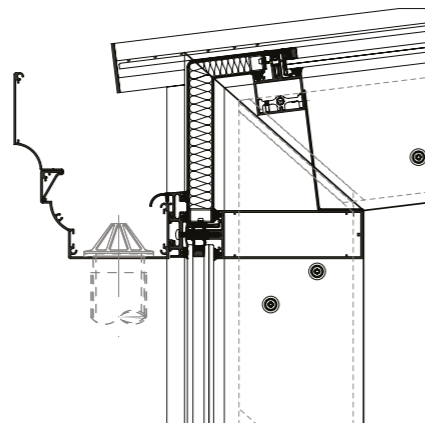
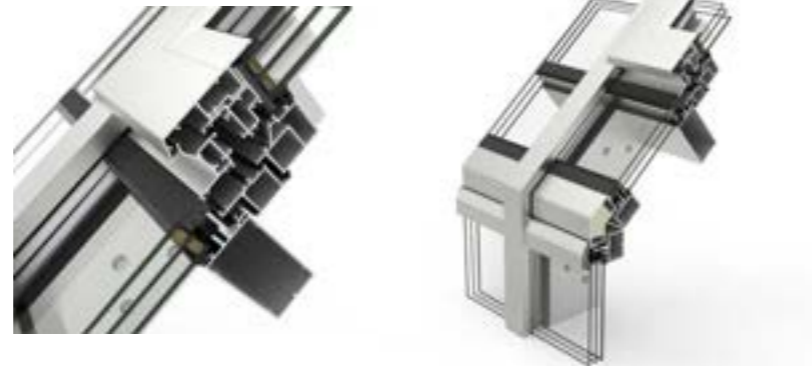

Sightlines

Mullion 52 mm
Transom 52 mm

Profile Thickness

2,1 & 3,0 mm
2,1 mm

Glazing

Fixed lights:
Max. 38 mm, Min. 26 mm

Window roof:
Max. 38 mm, Min. 24 mm

Minimum incline/slope Pt: 12% (7°)

Maximum incline/slope Pt: 85% (40°)

FEATURES

Transmittance Ucw ≥ 0,6 (W/m²K)

Air permeability Class AE

Watertightness Class RE1350

Wind resistance* Passed

Reference test 3,00 x 3,50 m
* Design loading 1200 Pa-Security loading 1800 Pa

PROJECTING OPENING TEST

Air permeability Class 4

Watertightness Class E2100

Wind resistance Class C5

Window reference test 1,23 x 1,14 mm / 1 sash

VERANDA



SLIDING ROOF

Sliding
Roof



Sliding and automatic enclosure system that allows the opening and closing of a roofed area, allowing to enjoy the fresh air or a roofed space depending on the circumstances. This solution grants a 66% maximum opening of the span, featuring, in addition, a notable thermal and acoustic comfort thanks to its glazing capacity of 24 mm and the installation of solar control glass. CORTIZO's Sliding Roof is equipped with a series of complementary profiles that adjust the enclosure's water collection and drainage, thus guaranteeing the system's maximum Watertightness.

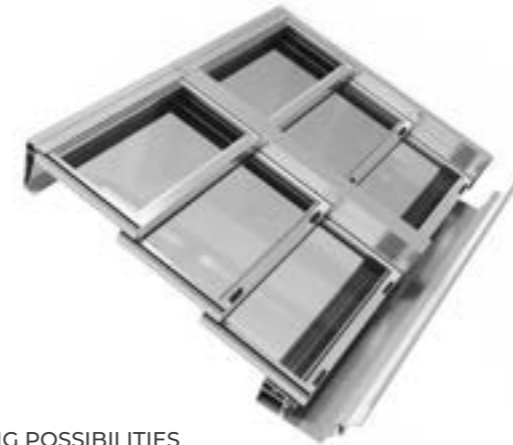

Sightlines

Frame 133 mm
Sash 28 mm

Profile Thickness

Sashes 1,5 mm

Glazing

Cellular polycarbonate 25 mm
Sandwich panel 24 mm
Glass 24 mm (4 tempered / 12 / 4+4)

Maximum Sash Dimensions

Width (L)
2300 mm (polycarbonate and sandwich panel)
1200 mm (glass)
Height (H) 1600 mm

Maximum Sash Weight:

75 Kg

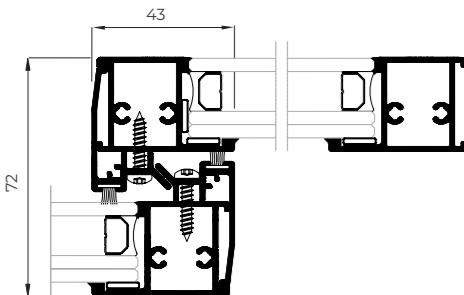

OPENING POSSIBILITIES

▽	▽	▽	▽
▽	▽	▽	▽

Outward Opening

2 sashes and 1 fixed module and multiple falls

Maximum Span Opening: 66%

Incline/Slope: 8,5% (15°)

Roof Distance

Max. 4800 mm, Min. 3100 mm

Roof Width

Unlimited when joining modules

Motorised sash opening

Roof system watertightness test: Class APT

During the 6 hr. test, end of test and 24 hrs. following the same, no drips or humidity were detected in the enclosed area
Reference test: 4300 x 4160 mm in 3 adjustable rows, 9 sashes and 4 / 12 / 4+4 glass

SLIDING ROOF



contemporary
enclosures



smoke and fire protection systems

Millennium FR

DOOR

Aluminium fire door system with fire resistance category EI₂60 in order to meet safety requirements in the event of fire, allowing the compartmentalisation by building areas and facilitating the evacuation of the users. It offers a fire resistance period of 60 minutes thanks to the use of non-combustible retardant insulation materials in the profile chambers and intumescent gaskets.

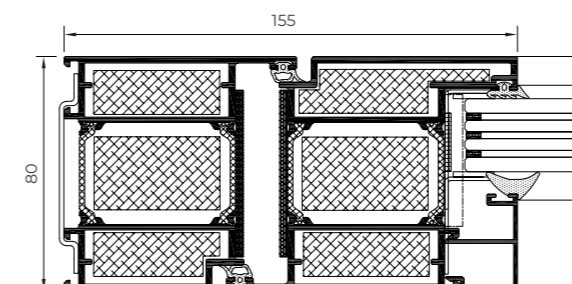

Sightlines

Frame 80 mm, Sash 80 mm

Polyamide Strip Length

35 mm

Profile Thickness

Door 2.2 mm

Glazing

Max. 48 mm, Min. 15 mm

Maximum Sash Dimensions



Width (L) 1450 mm, Height (H) 2600 mm

Maximum Sash Weight

240 kg

Consult maximum weight and dimensions according to typologies

FEATURES

Transmittance		$U_w \geq 1.4$ (W/m ² K)
Acoustic insulation		R _w up to 38 dB
Fire resistance and smoke control		Class EI ₂ 60-C5

Classification according to standard UNE-EN 13501-2+A1 (C5=200.000 test cycles)
Reference test 1.35 x 2.35 m / 1 sash, Class EI60 single glazed 23 to 25 mm.

OPENING POSSIBILITIES



Inward opening

Side hung









Outward Opening

Side hung

SHEV

The new SHEV system consists of a structure formed by an enclosure and an integrated motor which facilitates opening and closing. This motor is activated whenever there is a fire so as to enable the natural evacuation of heat and smoke upwardly. Its functions are to improve visibility and reduce the heat in the building, thus decreasing the risk of asphyxiation due to smoke inhalation and facilitating the evacuation of the people inside.

FEATURES

Transmittance		$U_w \geq 0,9$ (W/m ² K)
Acoustic insulation		Rw up to 44 dB
Reliability		Class Re1000
Opening under snow load		SL 60
Performance at low temperature		T(-5)
Wind load		WL 1200
Resistance to heat		B 300
Aerodynamic free area		According to calculation

Report N° 19-001796-PR15 (PP-A04-03-en-01)

MOTORISED OPENING POSSIBILITIES



Outward opening
Top hung

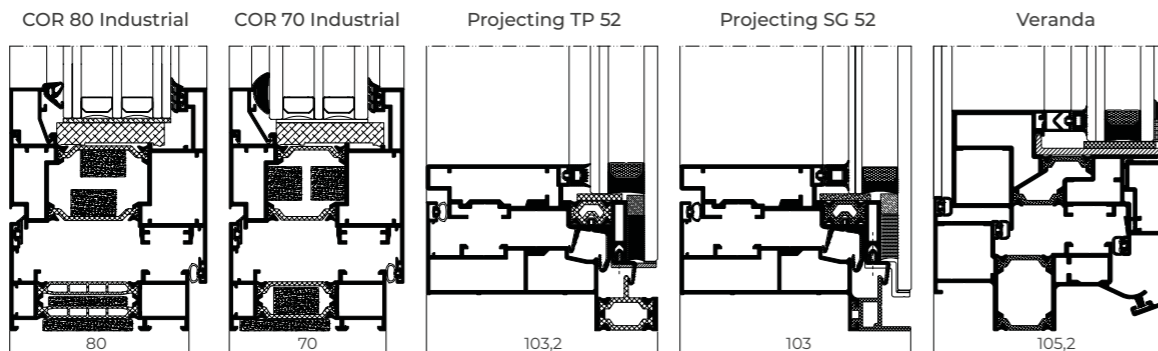

Smoke and fire protection



Glazing

Max. 65 mm*

(*Depending on the system and glass)

Maximum Sash Dimensions

Veranda:

Width (L) 2500 mm

Height (H) 2500 mm

Top hung:

Width (L) 2400 mm

Height (H) 2400 mm

Maximum Sash Weight

Veranda: 150 kg

Top hung: 165 kg

Consult maximum weight and dimensions according to typologies

Smoke and fire protection



contemporary
enclosures



claddings systems

CLADDING PRO

Transform your building with Cladding Pro, the modular and versatile aluminium cladding system that adapts to the needs of any architectural project. Its innovative design with clipped profiles and straight caps of various dimensions provides a modern and minimalist aesthetic, while ensuring quick and easy installation.

POSSIBILITY OF
FOILED PROFILES



MODEL 1

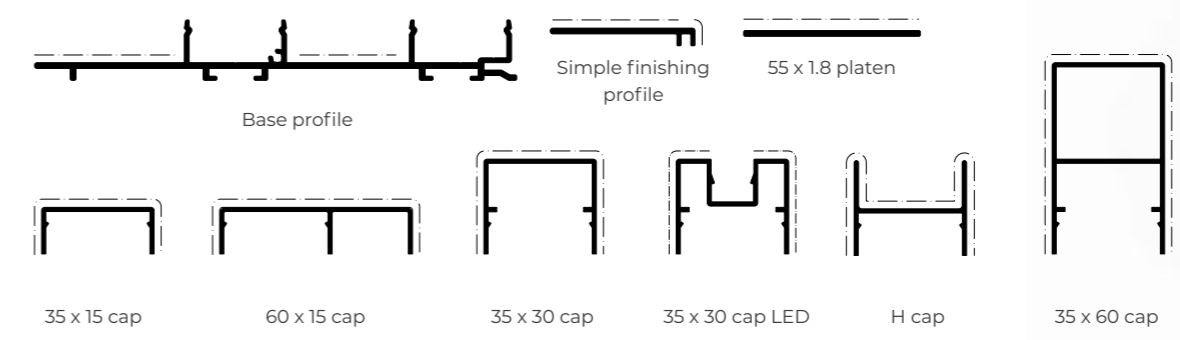

CLADDING PRO

Claddings



MODEL 2

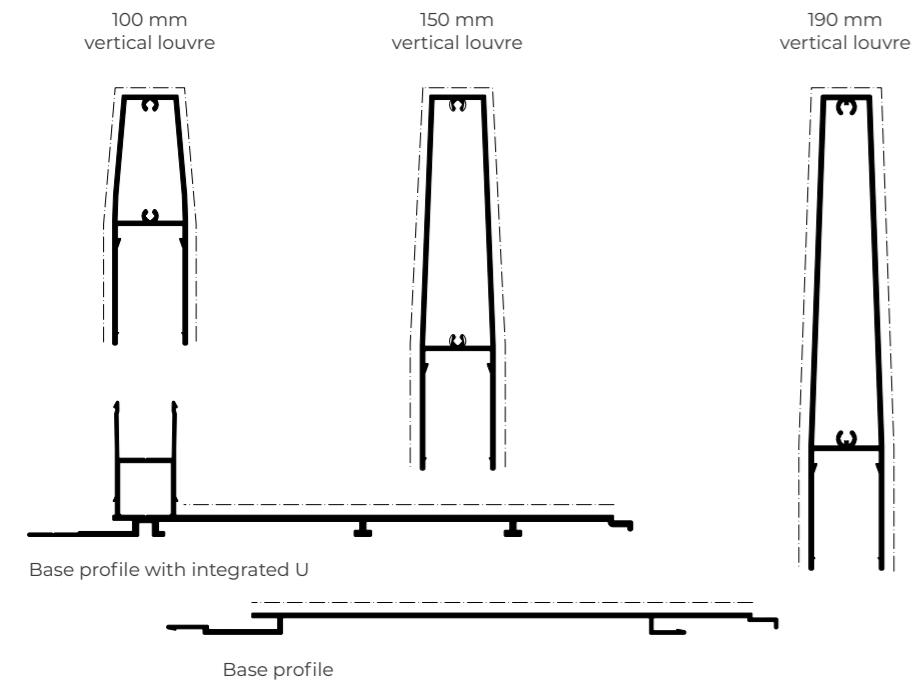

POSSIBILITY OF FOILED PROFILES



contemporary enclosures



interior divisions systems



PW 80

Office Partition Wall

Designed to divide interior spaces, available in glass and panel version. This solution allows the integration of side hung doors and venetian blinds.

FEATURES

Acoustic insulation  Rw up to 48 dB

Mechanical Performance  Category IV

Category IV reference test according to section 2.2.6 of EAD 210005-00-0505

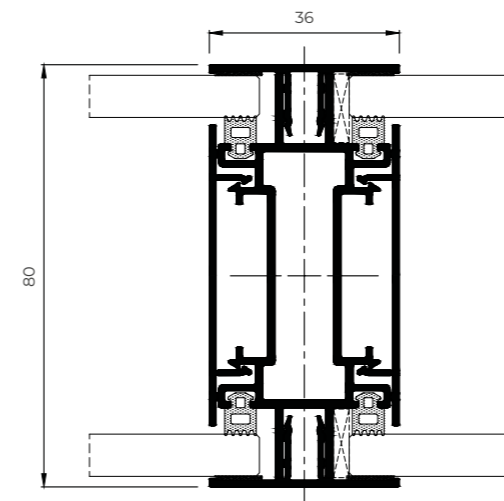

Sections

80 mm (mullion)

Profile thickness

1,5 mm (mullion)

Sightlines

12 / 24 / 36 mm

Panel

10 - 20 mm

Glazing

6+6, 8+8, 10+10, 12+12 mm

Máx. weigh

40 kg

Opening possibilities

8 and 10 mm Glass side hung door

40 mm Panel side hung door

Consult maximum weight and dimensions according to typologies



DESIGN 35

SCREEN AND INTERNAL DOOR

Cortizo presents the new screen and internal door DESIGN 35, an industrial-style solution, ideal for dividing spaces in line with contemporary design trends. Its 35 mm deep aluminium profiles and sightlines of only 32 mm allow the creation of structures that separate areas while maintaining visual continuity between rooms. With glazing options up to 12 mm, the system offers fixed light and hinged door configurations with frame, accompanied by a range of handles and accessories featuring exclusive finishes.

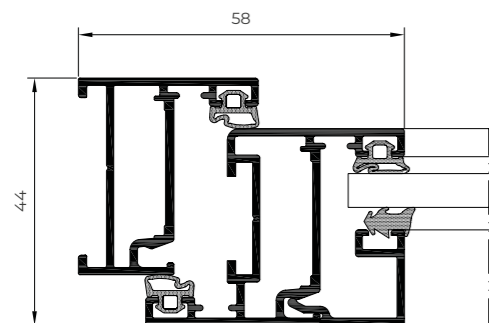

OPENING POSSIBILITIES

Fixed lights

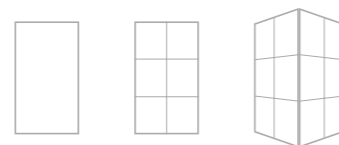

Side hung opening

Single sash

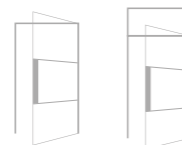

Double sash

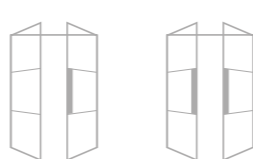

Side sightlines

32 mm fixed lights

58 mm opening

Glazing

Max. 12 mm, Min. 4 mm

Max. door dimensions

Width (L) 1,200 mm, Height (H) 2,600 mm

Max. weight per sash

90 kg per sash

Consult maximum weight and dimensions according to typologies



Interior
Divisions



DESIGN 35 SCREEN AND INTERNAL DOOR

contemporary
enclosures



solar protection systems

SOLAR PROTECTION LOUVRES

Efficient solution for solar ray incidence control in the building's interior temperature. Solar radiation is absorbed and reflected by these external louvres, facilitating energy efficiency and decreasing the need for artificial refrigeration. In addition, they serve as a decorative element bringing an avant-garde aesthetic to the façade.

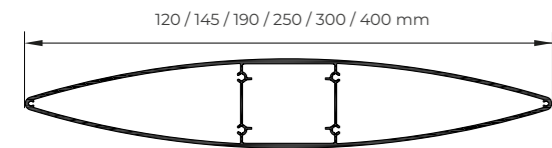

Louvre type

Fixed: Regulation 0°, 15°, 30° or 45°.

Adjustable: Motorized and manual.

Louvre size	Max recommended length to fixed louvres	Maximum recommended length to adjustable louvres
120 mm	1,8 metres	
145 mm	2,2 metres	1,9 metres
190 mm	2,5 metres	2,4 metres
250 mm	3,0 metres	3,0 metres
300 mm	3,5 metres	3,4 metres
400 mm	4,2 metres	4,0 metres

Depending on project specifications a larger free louvre length will be attainable (Consult)



Profile Thickness

Louvres	Thickness
120 mm	1,25 mm
145 mm	1,35 mm
190 mm	1,70 mm
250 mm	1,90 mm
300 mm	2,00 mm
400 mm	2,50 mm



Wind load resistance

Class 6 (max.)

Reference test

Louvres	Length
120 mm	1,8 metres
145 mm	2,0 metres
190 mm	2,5 metres
250 mm	3,0 metres
300 mm	3,5 metres
400 mm	4,2 metres

Test carried out according UNE 1932

Solar Protection



LATTICES DECORATIVE LOUVRES

Extruded aluminium slats designed to configure a double skin in external enclosures that allow to sieve the light facilitating air circulation.

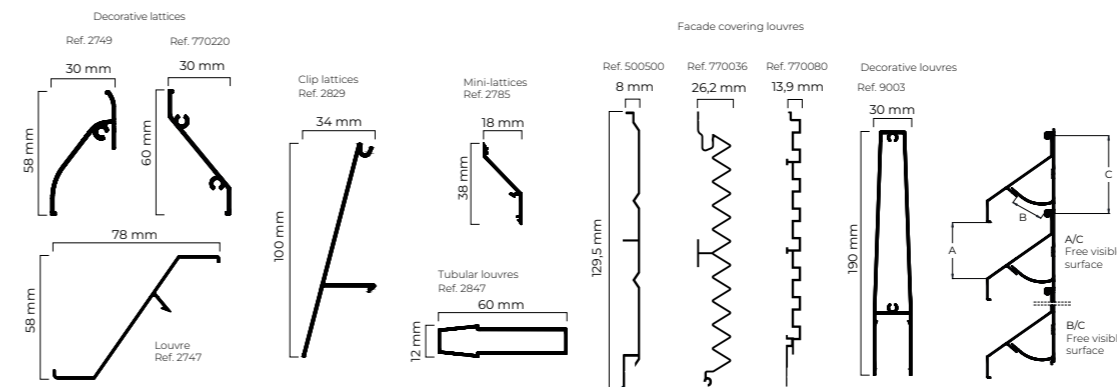

Wind load resistance

Lattice: UNE 13659 Class 6 (max.)

test reference 2.0 metres

Mini-lattice: UNE 13659 Class 5

Test reference 1.3 metres

Tubular louvres: UNE 13659 Class 6 (max.)

Test reference 1.3 metres

Test carried out according to -UNE 1932

Louvre type	Max. recommended free length	A/C	B/C
Lattices (Ref. 2747)	2,0 metres	71%	44%
Decorative lattices (Ref. 2749)	1,5 metres	62%	34%
Clip lattices (Ref. 2829)	2,0 metres	100%	24%
Mini-lattices (Ref. 2785)	1,3 metres	55%	39%
Tubular louvres (Ref. 2847)	2,0 metres	76%	-
Decorative louvres (Ref. 9003)	1,0 metres	86%	-
Façade covering louvres (Ref. 500500)	-	-	-
Façade covering louvres (Ref. 770036)	-	-	-
Façade covering louvres (Ref. 770080)	-	-	-



Solar Protection





SOLAR PROTECTION LOUVRES



LATTICES
DECORATIVE LOUVRES

JALOUSIE

Window system with glass or aluminium adjustable louvres, where the opening and closing is controlled by the different positions of the handle (button-operated handle available). Designed for tropical regions, this system is intended for the enclosure of spaces that require privacy and ventilation solutions, without thermal or acoustic performance demands. It offers the option of integrating a mosquito screen.

Solar
Protection

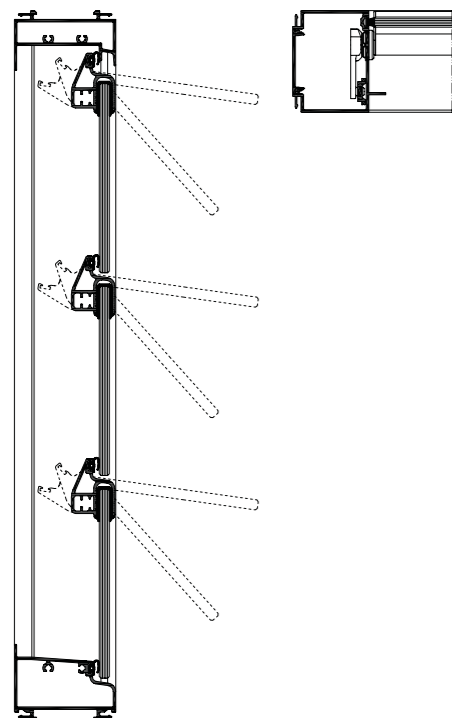

GLASS LOUVRES VERSION

ALUMINIUM LOUVRES VERSION

FEATURES

Air permeability		Class 4
Watertightness		Class 7B
Wind resistance		Class C5

Reference test 0,896 x 1,020 m, 8 louvres.

OPENING POSSIBILITIES

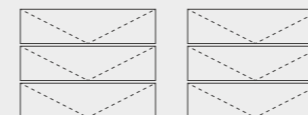

42°

82°

Outward opening:

42° and 82° opening positions

Sightlines

55 mm lateral frame

45 mm bottom frame

35 mm top frame

Glazing

6 mm

Louvre size

120 mm

Top adjustable louvre

Maximum louvre width

1000 mm

Maximum number of louvres per handle

10 u.



JALOUSIE

TAMIZ

Solar Protection



Side hung, sliding or bifold shutter system with fixed or adjustable louvres.

FEATURES	
Thermal resistance of the shutter and the thermal chamber	$\Delta R = 0,08 \text{ (m}^2\text{K/W)}$
Wind resistance	Class 5

Reference test 1,50 x 1,50 m / 2 sashes

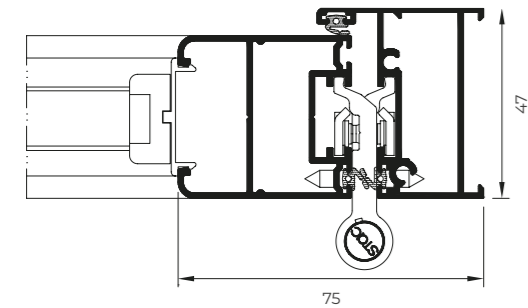

Sightlines

Frame 47 mm

Sash 40 mm

Profile Thickness

Window 1,3 mm

Door 1,5 mm

Maximum Sash Weight

Side hung 65 kg

Bifold 50 kg

Sliding 120 kg

Maximum Sash Dimensions

Side hung:

Width (L) 1200 mm, Height (H) 2500 mm

Bifold:

Width (L) 700 mm, Height (H) 2500 mm

Sliding:

Width (L) 2000 mm, Height (H) 3500 mm

Transmittance

Uw window transmittance
Uws transmittance of the window-shutter system

Uw(W/m ² K)	Uws(W/m ² K)
0,8	0,75
1,0	0,93
1,2	1,09
1,4	1,26
1,6	1,42
1,8	1,57
2,0	1,72
2,2	1,87
2,4	2,01
2,6	2,15
2,8	2,29
3,0	2,42
3,2	2,55



Closing possibilities

Closing with fixed or adjustable louvres

Opaque closing (sandwich panel)

Glazed closing

OPENING POSSIBILITIES

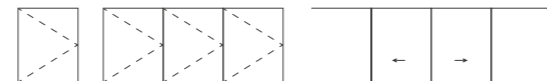

Side hung
Sliding
Bifold

MALLORQUINA

Solar Protection



Side hung shutter system with fixed or adjustable louvres

FEATURES	
Thermal resistance of the shutter and the thermal chamber	$\Delta R = 0,08 \text{ (m}^2\text{K/W)}$
Wind resistance	Class 5

Reference test 1,50 x 1,50 m / 2 sashes

Uw(W/m ² K)	Uws(W/m ² K)
0,8	0,75
1,0	0,93
1,2	1,09
1,4	1,26
1,6	1,42
1,8	1,57
2,0	1,72
2,2	1,87
2,4	2,01
2,6	2,15
2,8	2,29
3,0	2,42
3,2	2,55

Uw window transmittance
Uws transmittance of the window-shutter system

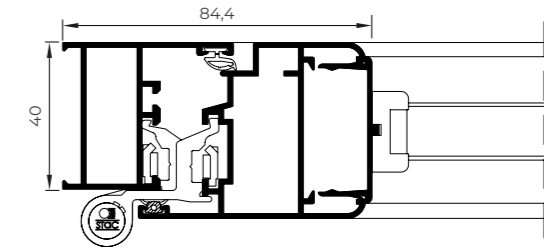

OPENING POSSIBILITIES



Side hung of 1, 2, 3 and 4 sashes

Sightlines

Frame 40 mm

Sash 48 mm

Profile Thickness

Window 1,3 mm

Door 1,4 mm

Maximum Sash Weight

75 Kg

Maximum Sash Dimensions

Width (L) 1500 mm

Height (H) 2400 mm





contemporary
enclosures



balustrading systems

BALUSTRADE

View Crystal Fit Plus

The View Crystal Fit Plus balustrade features adjustable packers that help reduce on-site time installation and facilitate the alignment of the glazing.

Balustrades

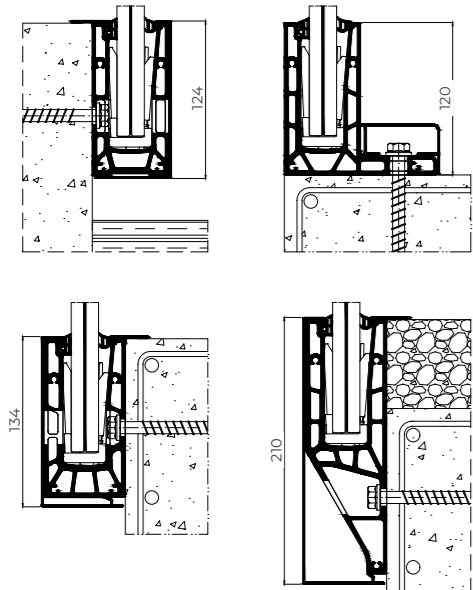

Assembly possibilities

- On slab
- On slab edge
- Flush on slab edge
- On inverted slab edge

Maximum height

1100 mm



It withstands a load of up to 3.0 kN/m. Suitable for use in zones A, B, C, D, E and F, as outlined in the CTE DB SE-AE, and A, B, C, D and E, in accordance with Eurocode 1. *Depending on the configuration.

LAMINATED GLASS COMPOSITIONS

10-1,52-10	10-1,14-10	10-0,76-10	10-0,38-10
8-1,52-8	8-1,14-8	8-0,76-8	8-0,38-8
6-1,52-6	6-1,14-6	6-0,76-6	6-0,38-6

Tests according to standards UNE 85237, UNE 85238 and UNE 85240. Established requirements in CTE (DB SU-1 and DB SE-AE) And established requirements in Eurocode 1 according to EN 1991-1-1/AC

- Static horizontal test towards the exterior
- Static horizontal test towards the interior
- Dynamic test with mild object
- Dynamic test with hard object
- Verification of section 3.2 of DB-SE-AE of CTE
- Verification of the specifications of the Eurocode 1 according to table 6.12 for use categories of 3kN/m

Classification according to UNE 85240, Class A-Excellent

- Reference test on balustrade with glass and extruded aluminium, fixed to the slab edge with (H) 1100 X (L) 1500 mm of total dimensions above ground level
- Reference test on balustrade with glass and extruded aluminium, fixed over the slab with (H) 1100 X (L) 1500 mm of total dimensions above ground level.

VIEW CRYSTAL FIT PLUS BALUSTRADE



BALUSTRADE

View Crystal / View Crystal Plus

Enjoy excellent views without any visual obstacle thanks to this balustrade system based on a "U" shaped aluminium profile on which laminated safety glass is fixed. Possibility of led strip illumination and drainage solution for exposed areas. Option of aluminium embellishing profile on the upper edge.

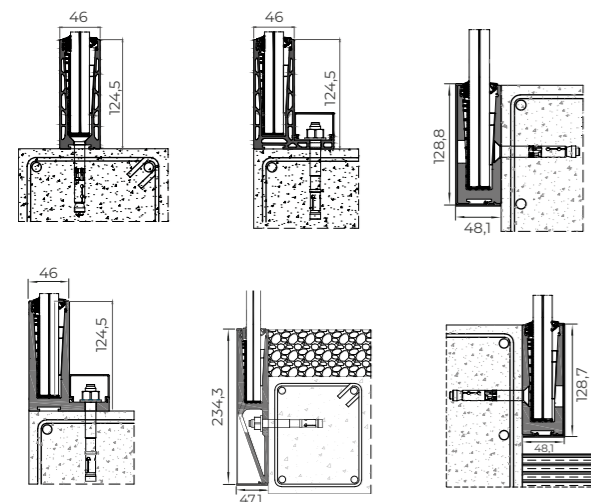

LAMINATED GLASS COMPOSITIONS

10-1,52-10	10-1,14-10	10-0,76-10	10-0,38-10
8-1,52-8	8-1,14-8	8-0,76-8	8-0,38-8
6-1,52-6	6-1,14-6	6-0,76-6	6-0,38-6

Balustrades



VIEW CRYSTAL: Resists a load of 1,0 kN/m applied at 1,1 metres from its bottom part. Suitable for use in areas A1, A2, B, C1, C2, D1, D2, G1 and G2, included in the CTE DB SE-AE, and A, B, C1, C2, C3, C4, D and E, in accordance with Eurocode 1.

VIEW CRYSTAL PLUS: Resists a load of 3,0 kN/m. Suitable for use in all areas from CTE DB SE-AE and areas A, B, C1, C2, C3, C4, C5, D and E, in accordance with Eurocode 1.



Assembly possibilities

- Over slab
- Flush over slab
- Edge slab
- Inverted edge slab
- Flush with the slab
- Flush with the pavement

Maximum height

1100 mm

Tests according to standards UNE 85237, UNE 85238 and UNE 85240. Established requirements in CTE (DB SU-1 and DB SE-AE) And established requirements in Eurocode 1 according to EN 1991-1-1/AC

Static horizontal test towards the exterior

Static horizontal test towards the interior

Dynamic test with mild object

Dynamic test with hard object

Verification of section 3.2 of DB-SE-AE of CTE

Verification of the specifications of the Eurocode 1 according to table 6.12 for use categories of 3kN/m

Classification according to UNE 85240, Class A-Excellent

Reference test on balustrade with glass and extruded aluminium, fixed to the slab edge with (H) 1100 X (L) 1500 mm of total dimensions above ground level

Reference test on balustrade with glass and extruded aluminium, fixed over the slab with (H) 1100 X (L) 1500 mm of total dimensions above ground level.

VIEW CRYSTAL BALUSTRADE



BALUSTRADE

Classic

Traditional balustrade system with bar or glass aspect.
Possibility of fixing to slab or to the edge of the slab.

Balustrades

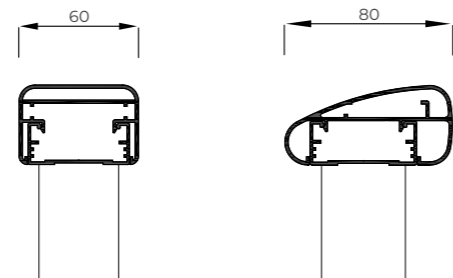

Possibilities

- Glass balustrading
- Glass balustrading with free top edge
- Bar balustrading
- Bar balustrading with free top edge

Handrail Possibilities

- Square - 60 mm width
- Circular - 66 mm diameter
- Elliptical - 80 mm external perimeter

Maximum Dimensions Between Pilasters

1000 mm

Minimum Height

900 mm

Classification according to UNE 85240, Class A-Excellent

Reference test on glass balustrading at a total height of (H) 1100 x (L) 2450 mm and 3 pilasters.
Reference test on bar balustrading with top free edge of (H) 1100 x (L) 2000 mm and 3 pilasters.

Tests according to standards UNE 85237, UNE 85238 and UNE 85210.

Requirements established in CTE (DB SU-1 and DB SE-AE)

Static horizontal test towards the exterior
Static horizontal test towards the interior
Static vertical test
Dynamic test with mild object
Dynamic test with hard object
Verification of section 3.2 of DB-SE-AE of CTE
Security test

CLASSIC BALUSTRADE



JULIET

Balcony

Balustrading solution for installation on the exterior of the carpentry by means of concealed fixings, allowing for the total opening of balconies without the risk of falling.

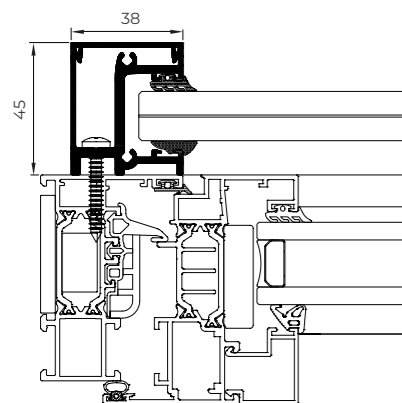

Classification according to UNE 85240, Class A-Excellent
Reference test on glass and extruded aluminium balustrade of (H) 1200 x (L) 1800 mm.

Tests according to standards UNE 85237, UNE 85238 and UNE 85240.
Requirements established in CTE (DB SU-1 AND DB SE-AE) and in Eurocode 1 according to EN 1991-1-1 for use category of up to 1,6 kN/m.

Static horizontal test towards the exterior.
Static horizontal test towards the interior.
Static vertical test.
Dynamic test with mild object.
Dynamic test with hard object.
Verification of section 3.2 of DB SE-AE of CTE.
Security test.

LAMINATED GLASS COMPOSITIONS	
8-1,52-8	6-1,52-6
8-1,14-8	6-1,14-6
8-0,76-8	6-0,76-6
8-0,38-8	6-0,38-6



Maximum width
1800 mm

Balustrades



JULIET
BALCONY

contemporary
enclosures



accessories



STYLISH HANDLE

The new Stylish handle presents a simple design, with more accentuated lines and stylish aesthetics for dressing in style the CORTIZO windows, balconies and doors.

WINDOW HANDLE



OFFSET HANDLE



HANDLE WITH KEY



DOOR HANDLE



Design with slim backplate
Version for external, internal and PVC assembly
Available in window and door version
Quick setting-up
Available in the full powder-coating range

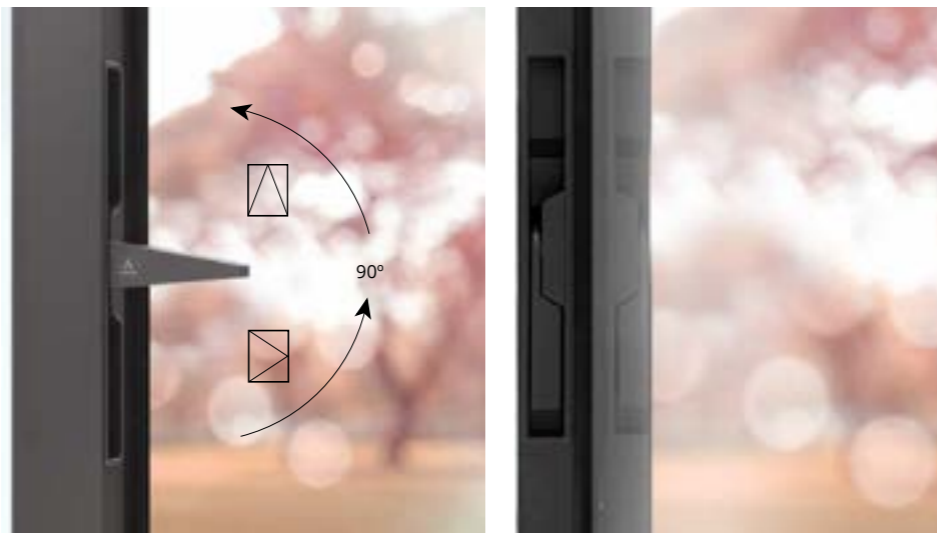
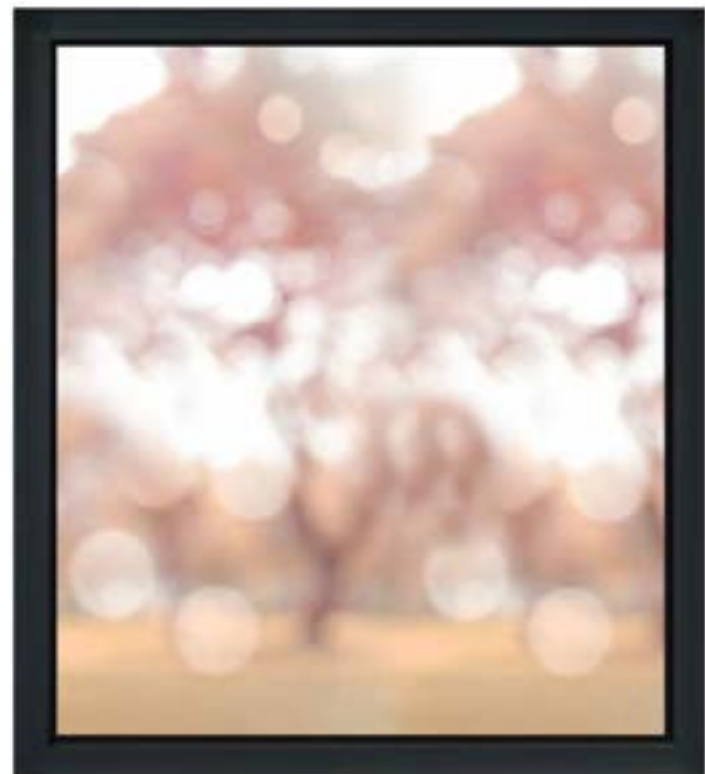

ARCH INVISIBLE HANDLE

Exclusive handle integrated within the sash, imperceptible from the frontal view

Compatible with the COR 80 Hidden Sash and COR 70 Hidden Sash systems
Ergonomics, robustness and easy handling in the opening and closing operations
Ideal for combination with concealed hinges, achieving a totally clean aesthetic
Dimensions 27.5 x 234 mm

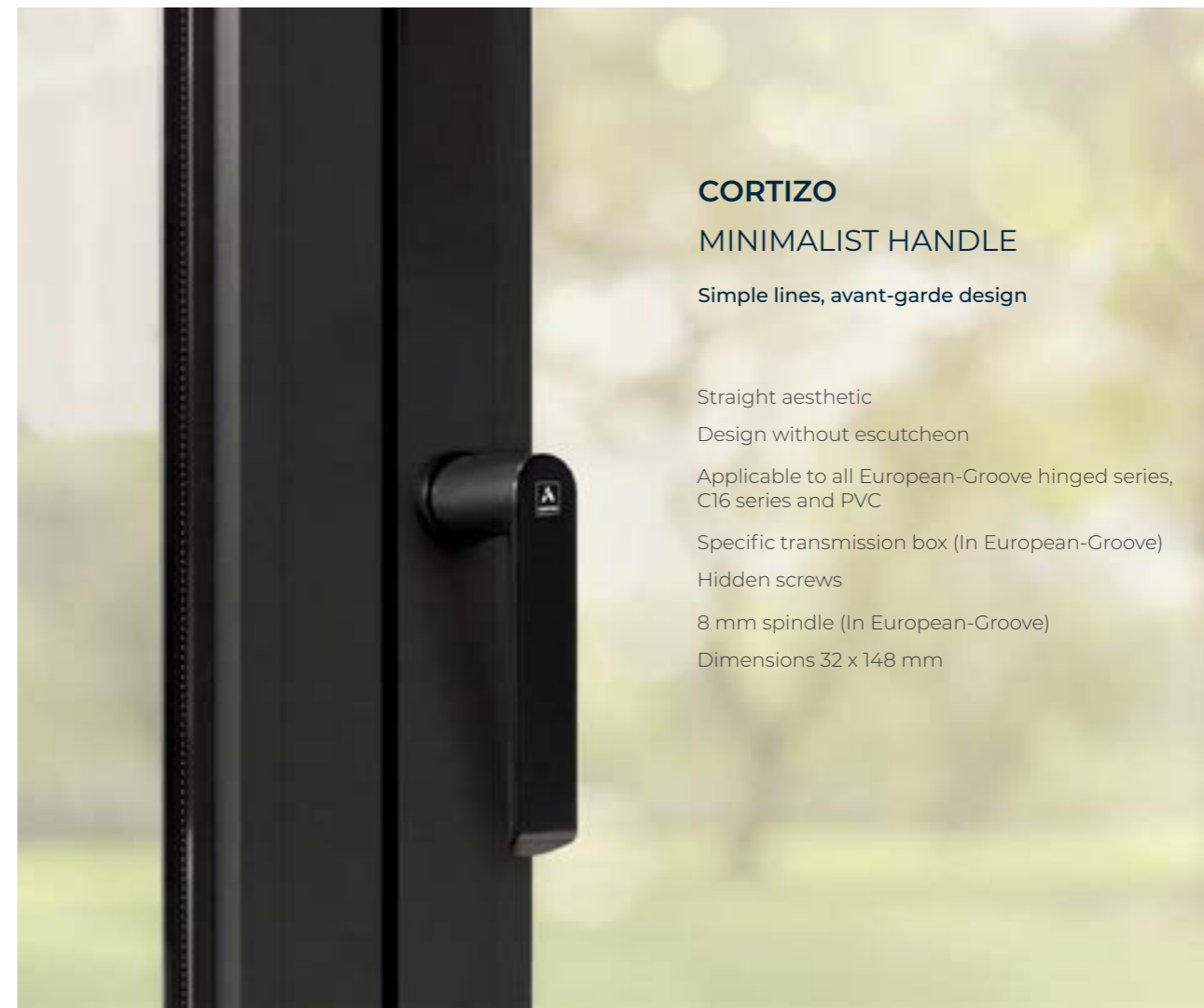

CORTIZO MINIMALIST HANDLE

Simple lines, avant-garde design

Straight aesthetic
Design without escutcheon
Applicable to all European-Groove hinged series, C16 series and PVC
Specific transmission box (In European-Groove)
Hidden screws
8 mm spindle (In European-Groove)
Dimensions 32 x 148 mm



CORTIZO HANDLE

Reduced escutcheon design
Adaptability to transmission box and multilock system
Concealed hardware
Spindle: 7 mm
Dimensions 32 x 148 mm



CORTIZO DOOR HANDLE

Reduced escutcheon design
Opening to the right and to the left versions
Suitable for exterior and interior assembly
Available in door version
Concealed hardware
Spindle: 8 mm
Dimensions 32 x 148 mm



INOX HANDLE

Reduced escutcheon design
Adaptability to transmission box and multilock system
Available in door version
Concealed hardware
Spindle: 7 mm
Dimensions: 31 x 135 mm



**SIRIUS
HANDLE**

Curved aesthetics
Design with a reduced escutcheon
Suitable for multipoint lock
Available for windows or doors
Spindle: 7 mm
Dimensions: 32 x 155 mm



**CORTIZO CREMONE
WITH KEY**

Maximum security
3 locking positions: full lock,
Bottom hung and tilt and
turn
Dimensions: 33 x 190 mm



**REMOVABLE
CORTIZO CREMONE**

Easy assembly
Handle clipped on the escutcheon
Possibility of removing the handle
in any position
Maximum durability
Dimensions: 33 x 173 mm



**ART INFINITY
PULL HANDLE**

Suitable for high traffic
and large dimension doors
Straight or curved design
Dimensions: 450 x 50 mm



**LIFT & SLIDE
HANDLE**

Avant-garde aesthetic
Exclusive to systems
4600 and 4700 Lift & Slide
Versions with or without key
Multiple combinations:
handle / handle
handle / finger pull
Tested to 25,000 cycles
Spindle of 10 mm
Dimensions: 37 x 290 mm



**CORTIZO OFFSET
HANDLE**

Handle specially designed
for sliding systems
Reduced escutcheon
Suitable for exterior and interior
Spindle: 7 mm
Dimensions: 32 x 158 mm



**VISION SECURITY
LOCK**

Key lockable
Integration of the locking
system in the profile with
minimalist aesthetics
Up to 4 locking points
Dimensions: 36 x 260 mm

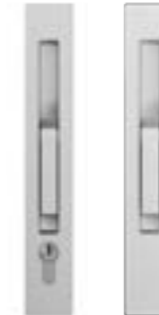

**FLUSH VISION
SECURITY LOCK**

Key lockable
Lock flush with the profile
Up to 4 locking points
Dimensions: 36 x 260 mm



**VISION SECURITY
MINI LOCK**

Straight aesthetics in line
with the minimalist style
of the system
Dimensions: 26 x 92 mm



**VISION
CENTRAL LOCK**

Suitable for the COR VISION and
COR VISION PLUS systems
Integrated in the interlock profile
It allows to conceal the
lateral sashes
Dimensions: 450 x 50 mm



CORTIZO HD HARDWARE

Hinge specially designed for large dimensions
such as floor to ceiling solutions

3D regulation

Maximum dimensions: 1200 x 3500 mm*

Maximum weight/sash: 160 Kg

* For window configurations of large dimensions and weight,
consult with the Cortizo Architecture and Engineering Department.



SPECIAL HARDWARES



EVO SOFT HARDWARE

3D regulation. All locking points are adjustable
Closing force up to 50% less than
traditional hardware

Possibility of multiple locking points

All sliding elements incorporate a clip to
eliminate unnecessary gaps

Maximum weight/sash: 120 Kg

For window configurations of large dimensions
and weight, consult with the Cortizo
Architecture and Engineering Department



EVO SOFT CLX 160 KG HARDWARE

3D regulation. All locking points are adjustable
Closing force up to 50% less than traditional
hardware

Possibility of multiple locking points

All sliding elements incorporate a clip to eliminate
unnecessary gaps

Maximum weight/sash: 160 Kg

For window configurations of large dimensions
and weight, consult with the Cortizo
Architecture and Engineering Department



EVO SECURITY HARDWARE

High security hardware
Mushroom security cams with tightness
adjustment and anti-theft locks
protection against breakage and robbery
Possibility of up to 14 locking points



